



PRODUCTO EN STOCK Y ENTREGA RÁPIDA
PRODUCT IN STOCK AND FAST DELIVERY
PRODUIT EN STOCK ET LIVRAISON RAPIDE



50

AÑOS / YEARS / ANS
EXPERIENCIA
EXPERIENCE
D'EXPERIENCE

ForLight25

by LedsC4



Acerca de Forlight

Forlight es una marca de iluminación de origen español y creada en Barcelona en 2015, cuyo objetivo es ofrecer soluciones óptimas de iluminación y ventilación al alcance de todos; con diseños que dan carácter a todos los espacios de un entorno residencial, tanto interiores como exteriores.

Avalados por los más de 50 años de experiencia de LedsC4, grupo de iluminación al que pertenece, Forlight ofrece una amplia cartera de productos, con el equilibrio óptimo entre coste, tecnología, material, diseño y eficiencia energética.

About Forlight

Forlight is a Spanish based lighting brand, set up in Barcelona in 2015, whose aim is to offer optimal lighting and fan solutions within everyone's reach. We are putting in faith on designs that give character to all spaces in a residential environment, both indoor and outdoor.

Endorsed by LedsC4's over 50 years' experience, group to which Forlight belongs, we are seeking to provide a wide product portfolio, with the optimal balance between cost, technology, material, design, and energy efficiency.

À propos de Forlight

Forlight est une marque de luminaires créée en 2015 à Barcelone en Espagne. Offrir des solutions d'éclairage et de ventilation optimales, et à la portée de tous, est son objectif. Forlight présente des designs qui apportent du caractère à tous les espaces résidentiels, tant à pour intérieur que pour l'extérieur.

Forts de 50 ans d'expérience du Groupe LedsC4 auquel Forlight appartient, nous cherchons à offrir un large éventail de produits dont l'équilibre coût, technologie matériaux, design et efficacité énergétique est optimal.

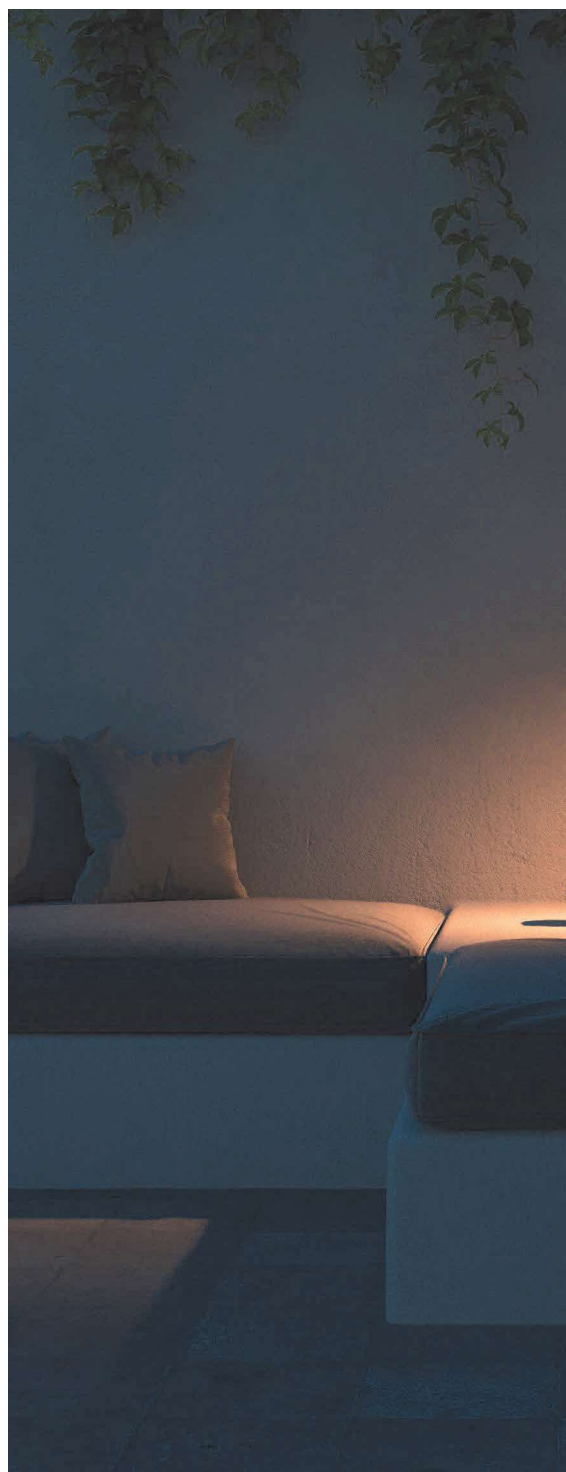

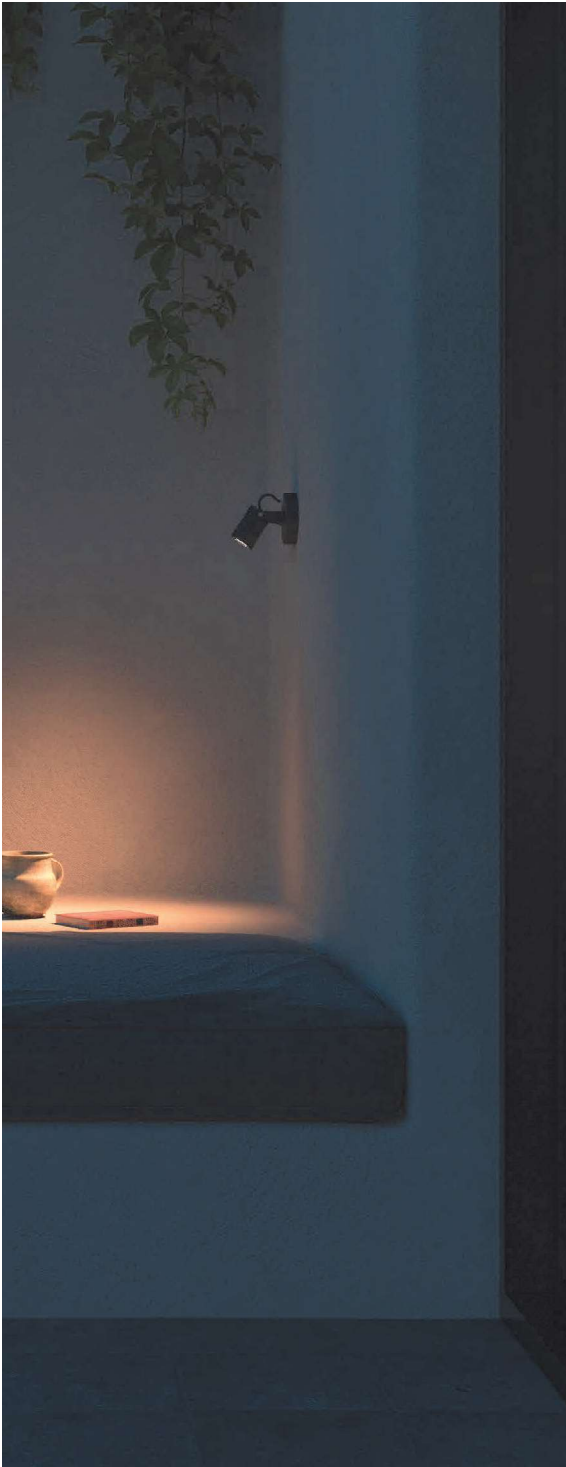

Diseño y calidad

Forlight cuenta con una amplia colección que cubre diferentes necesidades lumínicas y permite crear ambientes cálidos y espacios confortables.

La durabilidad, la facilidad de uso y la eficacia son el ADN de nuestros productos. Las luminarias Forlight son fáciles de instalar y ofrecen un buen rendimiento lumínico.

Todos nuestros productos se fabrican estrictamente de acuerdo con la normativa europea vigente.

Design and quality

Forlight has a wide collection that covers different lighting needs and allows you to create warm environments and comfortable spaces.

Durability, ease of use and effectiveness are the DNA of our products. Forlight luminaires are easy to install and have a good lighting performance.

All our products are strictly manufactured in accordance with current European regulations.

Design et qualité

Forlight propose une large collection qui couvre différents besoins d'éclairage et vous permet de créer des environnements chaleureux et des espaces confortables.

Durabilité, facilité d'utilisation et efficacité sont l'ADN de nos produits. Les luminaires Forlight sont faciles à installer et ont de bonnes performances d'éclairage.

Tous nos produits sont fabriqués dans le strict respect de la réglementation européenne en vigueur.

Sostenibilidad

Cuidamos nuestro entorno con el firme compromiso de generar un impacto social positivo y ambientalmente responsable.

Mejoramos la vida útil de nuestros productos desde el momento de su diseño para que sean reparables, duraderos y más fáciles de reciclar y así garantizar un producto más sostenible.

Utilizamos embalajes con certificación FSC y materiales procedentes de bosques gestionados de forma responsable de acuerdo con criterios de sostenibilidad.

Sustainability

We take care of our environment with a firm commitment to generating a positive and environmentally responsible social impact.

We improve the useful life of our products from the moment of their design so that they are repairable, durable, and easier to recycle, thus guaranteeing a more sustainable product.

We use FSC-certified packaging and materials from responsibly managed forests in accordance with sustainability criteria.

Durabilité

Nous prenons soin de notre environnement avec un engagement ferme à générer un impact social positif et écologiquement responsable.

Nous améliorons la durée de vie de nos produits dès leur conception afin qu'ils soient réparables, durables et plus faciles à recycler, garantissant ainsi un produit plus durable.

Nous utilisons des emballages certifiés FSC et des matériaux issus de forêts gérées de manière responsable selon des critères de durabilité.





Nuestro servicio

Disponer de productos con las especificaciones y la calidad adecuadas en el momento oportuno es la esencia de nuestra marca. Por ello, tenemos stocks permanentes en nuestros almacenes europeos y disponemos de puntos de servicios en más de 140 países, lo que nos permite garantizar una excelente experiencia de compra.

Our service

Having products with the right specifications and quality at the right time is the essence of our brand. Therefore, we aim to provide excellent experience to customers anywhere in the world, with service points in more than 140 countries, and permanent stocks of all catalogued products, in our European warehouses.

Nôtre service

Proposer des produits présentant les meilleures caractéristiques techniques et une qualité optimale à tout moment, c'est l'essence même de notre marque. C'est pourquoi nous offrons à nos clients une excellente expérience partout dans le monde, grâce à nos centres de service répartis dans plus de 140 pays, et grâce à des stocks permanents de tout produit catalogué dans nos entrepôts européens.

Index

Indoor Technical

Downlight empotrado
Recessed downlight
 Downlight encastré

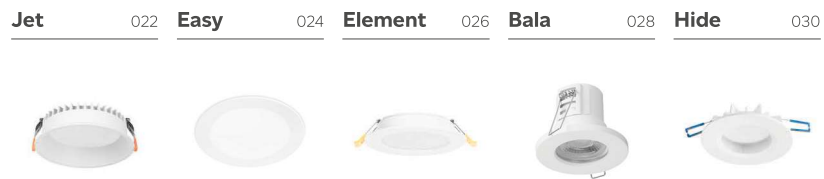

Mode 032 **Base** 033 **Dorit** 033 **Jim** 034 **Cardan** 035 **Sicro** 036



Sound Plus 037 **Lab** 038 **Ter** 039 **Feu** 040 **Minor** 041 **Rame** 041



Iluminación modular
Modular downlight
 Plafond d'éclairage modulaire



Downlight de superficie
Surface downlight
 Downlight surface



Luminaria
de superficie

*Surface
mounted*

Luminaire
de surface

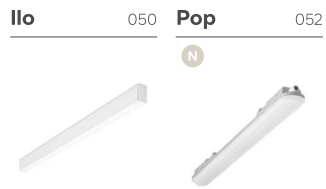

Panel LED

LED panel

Pavé LED



Proyector
de carril

Track spotlight

Projecteur
et rail



Iluminación
de paso

*Passageway
lighting*

Éclairage de
passage



Bathroom

Downlight
de superficie
*Surface
downlight*
Downlight
surface

Fab 066



Downlight
empotrado
*Recessed
downlight*
Downlight
encastré

Ter 068 **Rame** 070 **Minor** 070 **Lab** 071 **Feu** 071



Aplique pared
Wall lamp
Applique

Sfera 072 **Giro** 074 **Metà** 075 **Passeggio** 076



Nora 078 **Lungo** 079



Espejo
Mirror
Miroir

Lizz 080 **Zico** 082



Indoor Decorative

Colgante <i>Pendant lamp</i> Suspension	Cortic 090	Dama 092	Riba 094	Viva 095	Stac 096
					
	Fres 098	Nube 100	Era 101		
					
Aplique pared <i>Wall lamp</i> Applique	Duplo 102	Meds 104	Fres 106	Thin 108	Keep 108
					
	Toppi 109	Ander 110	Glass 111	Niza 111	
					

Sobremesa **Cortic** 112 **Viva** 114 **Fres** 116 **Nuts** 118 **Meds** 120

Table Lamp

Lampes de table



Ding 121

Touch 122

Zenit 123



Pie de salón

Floor lamp

Lampadaires

Viva 124

Fres 126

Meds 128

Ding 129



Luminaria de superficie

Surface mounted

Luminaire de surface

Stac 130

Farrow 132

N



Serie de focos

Spot series

Séries de spots

Kaplan 134

Era 136

Nature 138

Eufo 140

N





















Luz de lectura **Era** 142 **Colo** 143 **Crobat** 144 **Mine** 145 **Bas** 146
Reading light
Lampe de lecture

















































Lyon 147 **Aura** 148 **Janet** 149



Outdoor

Solar	Olaf 158	Ret 159	Cero 160	Deco 162	Lis 162
Solar					
Solaire					
Top 163					
					
Empotrable de suelo	Tidian 164	Ringo 166	Incasso 167	Up 168	
Uplight recessed					
Encastré sol					
Luz de señalización	Senya 170	172	Way 174		
Wayfinding lighting					
Éclairage de signalisation					
Empotrable de pared	Zilo 176	Rect 178	Icon 179	Tamesis 180	Stair 181
Recessed wall fixture					
Applique encastré					

Projector	Vista 182	Crest 184	Trim 186	Fint 188	Pious 190
Spotlight	N	N			
Projecteur					
Neo 192	Lis 192	Minimal 193	Jumbo 194	Hit 195	Ousia 196
					
Pixa 198	Tidian 198	Post 199			
					
Projector de pared	Vista 200	Pixa 202	Eleve 203		
Wall spotlight	N				
Projecteur mural					

Aplique pared Wall lamp Applique	Moo 204	Vit 206	New flash 207	Eclipta I 208	Eclipta II 210	
						
	Wilow 212	Kapa 212	Yika 213	Slim 214	Rex 216	Olaf 218
						
	Ret 219	Top 220	Block 220	Samper 221	Zenitha 221	One 222
						
	Auro 224	Creu 226	Kairo 228	Nod 232	Loyd 232	Hide 233
						
	Orion 234	Ara 238	Fond 240	Cone 242	Kala 243	Avenue 244
						

Alan 245 **Foix** 246 **Prisma** 247 **Area** 248 **Cube** 250 **Kubo** 251















Osaka 252 **Mayor** 253 **Thomas** 254 **Siluet** 254 **Quanta** 255 **Veta** 256



Astra 257



Baliza <i>Bollard</i> Balise	Eclipta I 258	Eclipta II 260	One 262	Hide 264	Yika 265	
						
	Arrow 266	Top 267	Astra 268	Veta 270	Pixa 272	Cone 273
						
	Indoo 274	Mandela 275	Kala 276	Koral 276	Siljan 277	Alfil 277
						
Luminaria de superficie <i>Surface mounted</i> Luminaire de surface	Orion 278	Crest 280	Ford 282	Scal 283		
						

Portable

Portátil

Portable

Portable

Pomer 286



Treta 288



Sirina 290



Baser 292



Rorer 294



Deco 296



Fans

Ventiladores

Fans

Ventilateurs

Stem Evo 302

N



Stem 310



Bosc 312

N



Pam 314

N



Helix 316

N



Shadow 318

N



Bora 320



Lace 322



Garbí 324



Calar 326



July 328



Windy 330



Nepal 332



Phuket 334



Formentera 336



Bambu 338 **Mim** 339 **Cil** 340 **Merak** 341



Borneo 342 **Mogan** 344 **Rodas** 346 **Kudari** 347



Klar 348 **Zonda** 348



Downlight empotrado
Recessed downlight
Downlight encastré

Jet	022
Easy	024
Element	026
Bala	028
Hide	030
Mode	032
Base	033
Dorit	033
Jim	034
Cardan	035
Sicro	036
Sound Plus	037
Lab	038
Ter	039
Feu	040
Minor	041
Rame	041

Iluminación modular
Modular downlight
Plafond d'éclairage modulaire

Mix LED	042
Mix GU10	043

Downlight de superficie
Surface downlight
Downlight surface

Jet	N 044
Easy	046
Era	N 048

Luminaria de superficie
Surface mounted
Luminaire de surface

Ilo	050
Pop	N 052

Panel LED
LED panel
Pavé LED

Square eco	053
-------------------	-----

Proyector de carril
Track spotlight
Projecteur et rail

Tent	N 054
Luvo	056

Iluminación de paso
Passageway lighting
Éclairage de passage

Zilo	N 058
Senya	N 060
Icon	062
Nod	062
Kairo	N 063



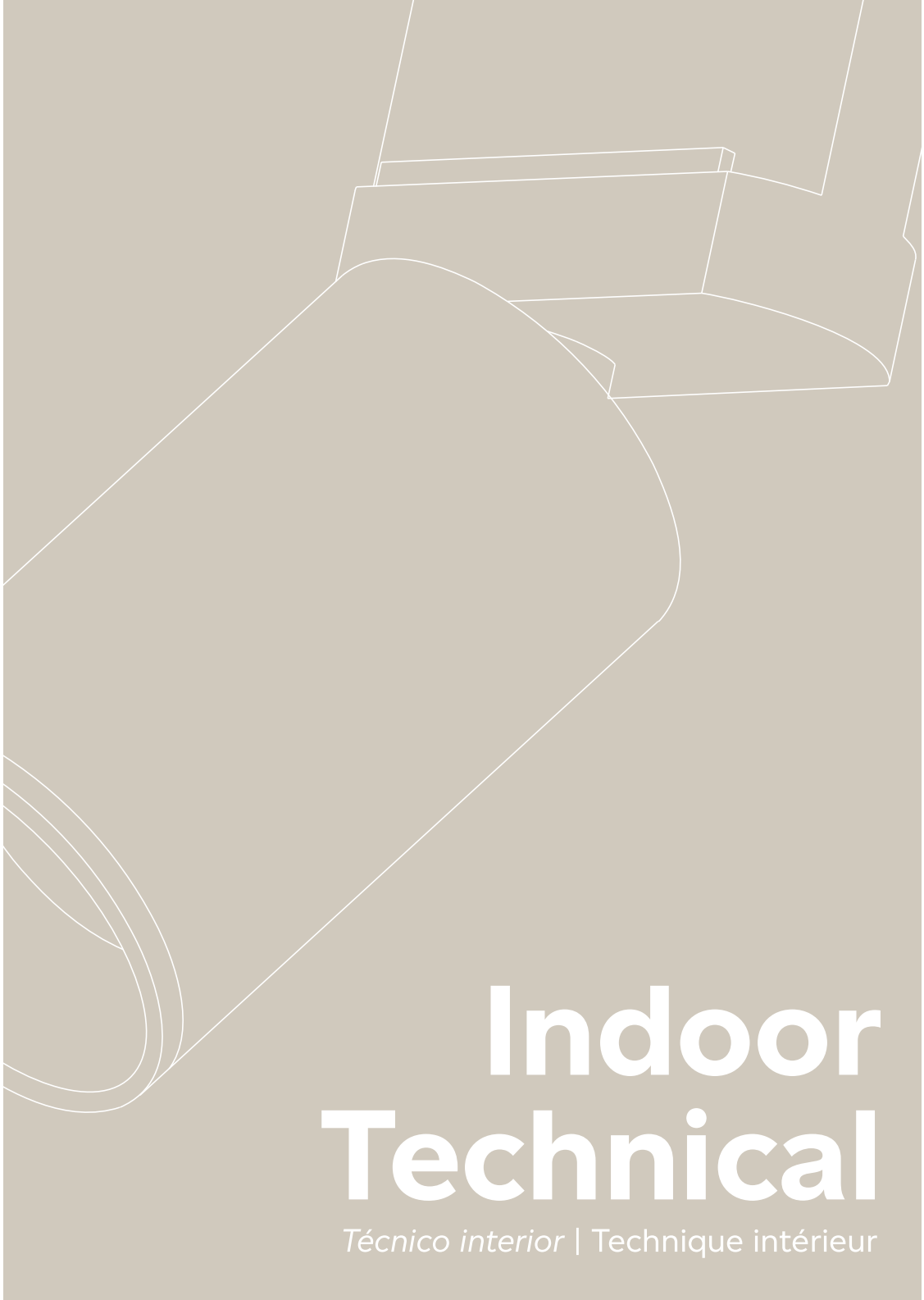

Indoor Technical

Técnico interior | Technique intérieur

Recessed downlight

Forlight

Jet

MAT
Aluminium

DIF
Polystyrene

CLASS II
100-240V / 50-60Hz



TC-0000 / TC-0001

TC-0002 / TC-0003

TC-0004 / TC-0005

TC-0006 / TC-0007

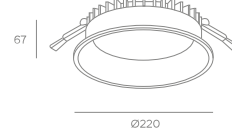
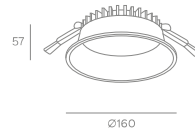
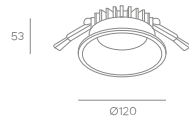
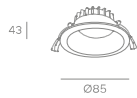

Code	Size	Color	Power	Kelvin	Rated flux	Units
TC-0000-BLA	D85xH43mm	○ White	7W	3000K	720 lm	50
TC-0000-NEG	D85xH43mm	● Black	7W	3000K	720 lm	50
TC-0001-BLA	D85xH43mm	○ White	7W	4000K	720 lm	50
TC-0001-NEG	D85xH43mm	● Black	7W	4000K	720 lm	50
TC-0002-BLA	D120xH53mm	○ White	10W	3000K	1020 lm	40
TC-0002-NEG	D120xH53mm	● Black	10W	3000K	1020 lm	40
TC-0003-BLA	D120xH53mm	○ White	10W	4000K	1020 lm	40
TC-0003-NEG	D120xH53mm	● Black	10W	4000K	1020 lm	40
TC-0004-BLA	D160xH57mm	○ White	20W	3000K	2135 lm	20
TC-0004-NEG	D160xH57mm	● Black	20W	3000K	2135 lm	20
TC-0005-BLA	D160xH57mm	○ White	20W	4000K	2135 lm	20
TC-0005-NEG	D160xH57mm	● Black	20W	4000K	2135 lm	20
TC-0006-BLA	D220xH67mm	○ White	30W	3000K	3300 lm	20
TC-0006-NEG	D220xH67mm	● Black	30W	3000K	3300 lm	20
TC-0007-BLA	D220xH67mm	○ White	30W	4000K	3300 lm	20
TC-0007-NEG	D220xH67mm	● Black	30W	4000K	3300 lm	20

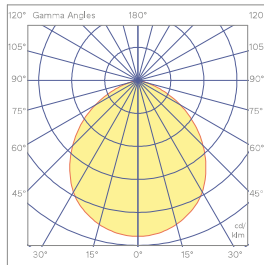

H[m]	D[m]	Max lux	Med lux	Alpha=50.1°+50.1°	G=0.0
1.00	2.39	1147	360		
2.00	4.78	287	90		
3.00	7.17	127	40		
4.00	9.56	72	23		
5.00	11.95	46	14		

Value based on TC-0007-BLA

Jet collection



Surface
downlight
P. 044



Recessed downlight

Indoor Technical

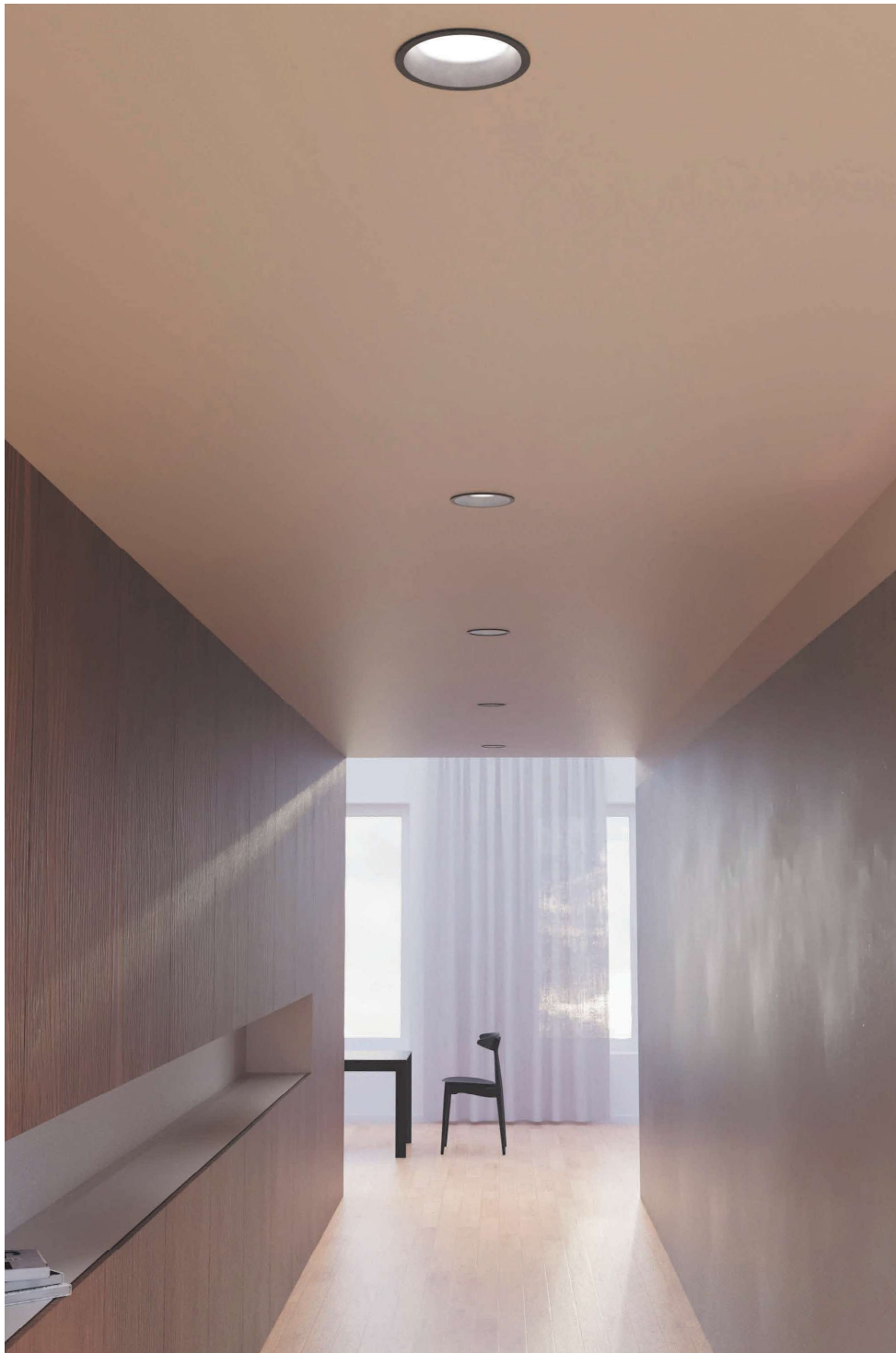

Easy

MAT
Aluminium

DIF
Acrylic

CLASS II
100-240V / 50-60Hz



TC-0148 / TC-0149



∠0158 □ 0-12mm

TC-0150 / TC-0151



∠0205 □ 0-12mm

TC-0203 / TC-0204

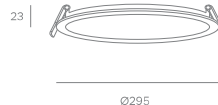

∠0285 □ 0-12mm

Code	Size	Color	Power	Kelvin	Rated flux	Units
TC-0148-BLA	D170xH23mm	○ White	12W	3000K	1150 lm	40
TC-0149-BLA	D170xH23mm	○ White	12W	4000K	1150 lm	40
TC-0150-BLA	D225xH23mm	○ White	18W	3000K	1510 lm	20
TC-0151-BLA	D225xH23mm	○ White	18W	4000K	1510 lm	20
TC-0203-BLA	D295xH23mm	○ White	22W	3000K	2160 lm	10
TC-0204-BLA	D295xH23mm	○ White	22W	4000K	2160 lm	10

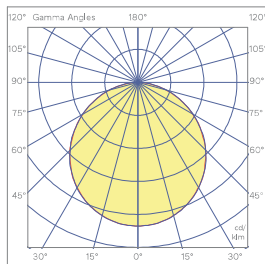

H[m]	D[m]	Max lux	Med lux	Alpha=56.4°*56.4°	G=0.0
1.00	3.01	585	141		
2.00	6.03	146	35		
3.00	9.04	65	16		
4.00	12.06	37	9		
5.00	15.07	23	6		

Value based on TC-0204-BLA



Recessed downlight

Indoor Technical

MAT
Aluminium

DIF
Acrylic

CLASS II
100-240V / 50-60Hz



TC-0154 / TC-0155

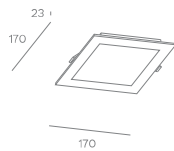

155x155 0-12mm

TC-0156 / TC-0157

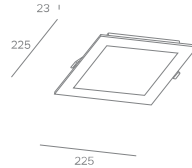

205x205 0-12mm

TC-0212 / TC-0213

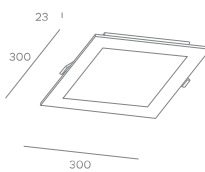

285x285 0-12mm

Code	Size	Color	Power	Kelvin	Rated flux	Units
TC-0154-BLA	L170xH23mm	○ White	12W	3000K	1150 lm	40
TC-0155-BLA	L170xH23mm	○ White	12W	4000K	1150 lm	40
TC-0156-BLA	L225xH23mm	○ White	18W	3000K	1510 lm	20
TC-0157-BLA	L225xH23mm	○ White	18W	4000K	1510 lm	20
TC-0212-BLA	L300xH23mm	○ White	22W	3000K	2160 lm	10
TC-0213-BLA	L300xH23mm	○ White	22W	4000K	2160 lm	10

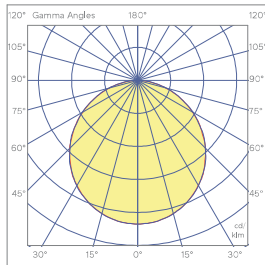

H[m]	D[m]	Max lux	Med lux	Alpha=56.4°+56.4°	G=0.0
1.00	3.01	585	141		
2.00	6.03	146	35		
3.00	9.04	65	16		
4.00	12.06	37	9		
5.00	15.07	23	6		

Value based on TC-0213-BLA

Easy collection



Surface
downlight
P. 046



Element

MAT
Polycarbonate

DIF
Technopolymer

CLASS II
220-240V / 50-60Hz

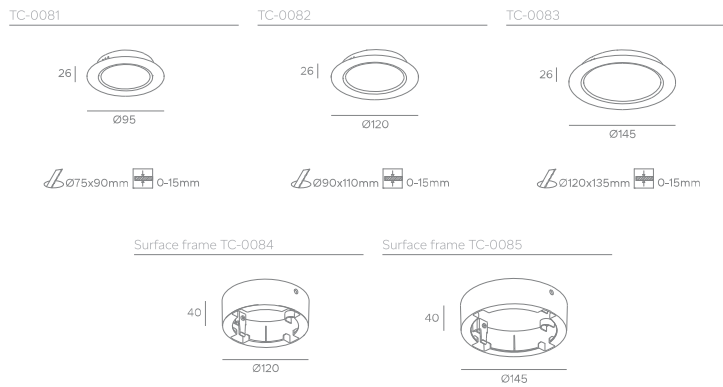

Code	Size	Color	Power	Kelvin	Rated flux	Units
TC-0081-BLA	D95x26mm	○ White	5W	3000K - 4000K - 6000K	784 lm*	100
TC-0082-BLA	D120x26mm	○ White	9,5W	3000K - 4000K - 6000K	1600 lm*	100
TC-0083-BLA	D145x26mm	○ White	11,5W	3000K - 4000K - 6000K	1890 lm*	60

*Value based on 4000K.

Accessory code	Size	Description	Units
TC-0084-BLA	D120x40mm	Surface frame for TC-0082	100
TC-0085-BLA	D145x40mm	Surface frame for TC-0083	60

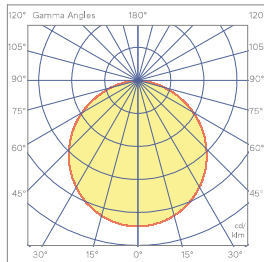

H[m]	D[m]	Max lux	Med lux	Alpha=56.3°+56.3°	G=0.0
1.00	2.99	391	95		
2.00	5.99	98	24		
3.00	8.98	43	11		
4.00	11.98	24	6		
5.00	14.97	16	4		

Value based on TC-0083-BLA



Recessed downlight

Indoor Technical



Recessed downlight

Forlight

Bala

MAT
Aluminium

DIF
Polycarbonate

CLASS II
220-240V / 50-60Hz

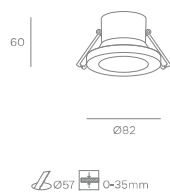

Code	Size	Color	Power	Kelvin	Rated flux	Units
TC-0440-BLA	D82xH60mm	○ White	5,2W	3000K	510 lm	20
TC-0472-BLA	D82xH60mm	○ White	8,9W	3000K	850 lm	20
TC-0491-BLA S	D82xH60mm	○ White	8,9W	2700K	810 lm	20



Recessed downlight

Indoor Technical



Recessed downlight

Forlight

Hide

MAT
Aluminium

DIF
Glass

CLASS II
100-240V / 50-60Hz

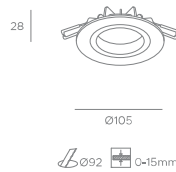

Code	Size	Color	Power	Kelvin	Rated flux	Units
TC-0175-BLA	D105xH28mm	○ White	7,8W	3000K	890 lm	20
TC-0215-BLA S	D105xH28mm	○ White	7,8W	4000K	890 lm	20
TC-0176-BLA	D105xH28mm	○ White	10,9W	3000K	1150 lm	20
TC-0216-BLA S	D105xH28mm	○ White	10,9W	4000K	1150 lm	20



Recessed downlight

Indoor Technical



Mode

MAT
Polycarbonate

DIF
Polycarbonate

CLASS II
100-240V / 50-60Hz



TC-0072

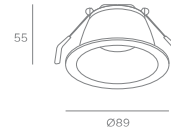

∠Ø75mm ⊕ 0-20mm



TC-0073

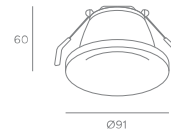

∠Ø75mm ⊕ 0-20mm



TC-0074

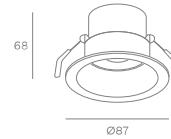

∠Ø75mm ⊕ 0-20mm

Lighting effect of the collection



Code	Size	Color	Power	Kelvin	Rated flux	Units
TC-0072-BLA S	D89xH55mm	○ White	5,4W	3000K	605 lm	48
TC-0073-BLA S	D91xH60mm	○ White	5,4W	3000K	605 lm	48
TC-0074-BLA S	D87xH68mm	○ White	5,4W	3000K	605 lm	48

TC-0074



Recessed downlight

Indoor Technical

Base

MAT
Aluminium

DIF
Glass

CLASS II
100-240V / 50-60Hz



Code	Size	Color	Power	Kelvin	Rated flux	Units
TC-0502-BLA	D95xH52mm	○ White	7W	3000K	820 lm	20



Dorit

MAT
Aluminium

DIF
Glass

CLASS II
100-240V / 50-60Hz

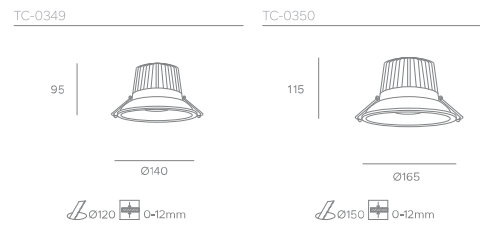

Code	Size	Color	Power	Kelvin	Rated flux	Units
TC-0349-BLA	D140xH95mm	○ White	15,7W	3000K	1530 lm	18
TC-0350-BLA S	D165xH115mm	○ White	18,7W	3000K	2300 lm	12



Recessed downlight

Forlight

Jim

MAT
Aluminium

DIF
Polycarbonate

CLASS II
220-240V / 50-60Hz



TC-0118

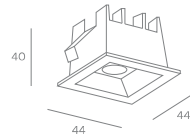

TC-0119

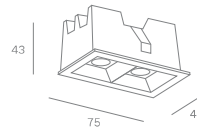

TC-0120

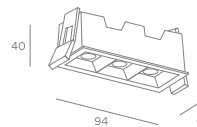

TC-0121

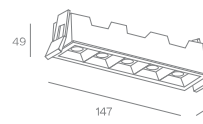

Code	Size	Color	Power	Kelvin	Rated flux	Units
TC-0118-BLA	L44xH40mm	○ White	2,3W	3000K	170 lm	100
TC-0119-BLA	L75xH43mm	○ White	3,9W	3000K	340 lm	100
TC-0120-BLA	L94xH40mm	○ White	5,6W	3000K	510 lm	50
TC-0121-BLA	L147xH49mm	○ White	10,3W	3000K	850 lm	50



Recessed downlight

Indoor Technical

Cardan

MAT
Steel

CLASS II
100-240V / 50-60Hz



TC-1500

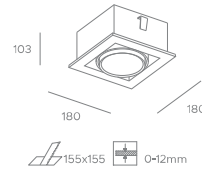

Code	Size	Color	Power	Units
TC-1500-BLA	L90xH52mm	○ White	Max. 15W (LED)	12



TC-1400

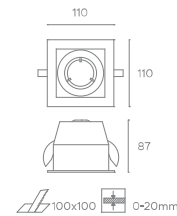

TC-1401

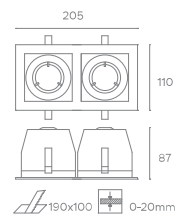

Compatible with module MIX TC-0070, TC-0071 (P. 042)

Code	Size	Color	Power	Units
TC-1400-BLA	L110xH87mm	○ White	Max. 8W (LED)	32
TC-1401-BLA	L205xH87mm	○ White	2x Max. 8W (LED)	16



Bulb not included

Recessed downlight

Forlight

Sicro

MAT
Aluminium

CLASS II
100-240V / 50-60Hz



TC-0113

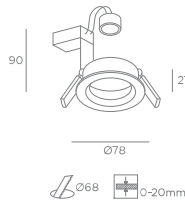

TC-0112

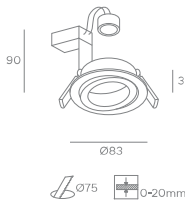

Code	Size	Color	Power	Units
TC-0113-BLA	D78xH90mm	○ White	Max. 8W (LED)	100
TC-0113-NEG	D78xH90mm	● Black	Max. 8W (LED)	100
TC-0112-BLA	D83xH90mm	○ White	Max. 8W (LED)	100
TC-0112-NEG	D83xH90mm	● Black	Max. 8W (LED)	100

TC-0112

Bulb not included

Recessed downlight

Indoor Technical

Sound Plus

MAT
Aluminium

CLASS II
100-240V / 50-60Hz



TC-0134

24



Ø78

∠Ø65mm ⊕ 0-12mm

TC-0135

19



Ø81

∠Ø75mm ⊕ 0-12mm

Code	Size	Color	Power	Units
TC-0134-BLA	D78xH90mm	○ White	Max. 8W (LED)	100
TC-0135-BLA	D81xH90mm	○ White	Max. 8W (LED)	100



Bulb not included



TC-0135

Recessed downlight

Forlight

Lab

MAT
Steel

DIF
Glass

CLASS II
100-240V / 50-60Hz

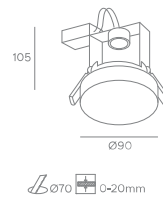

Code	Color	Power	Units
DE-0132-BLA	○ White finish	Max. 8W (LED)	50



38
Bulb not included

Recessed downlight

Indoor Technical

Ter

MAT
Aluminium

DIF
Glass

CLASS II
100-240V / 50-60Hz

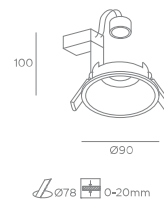
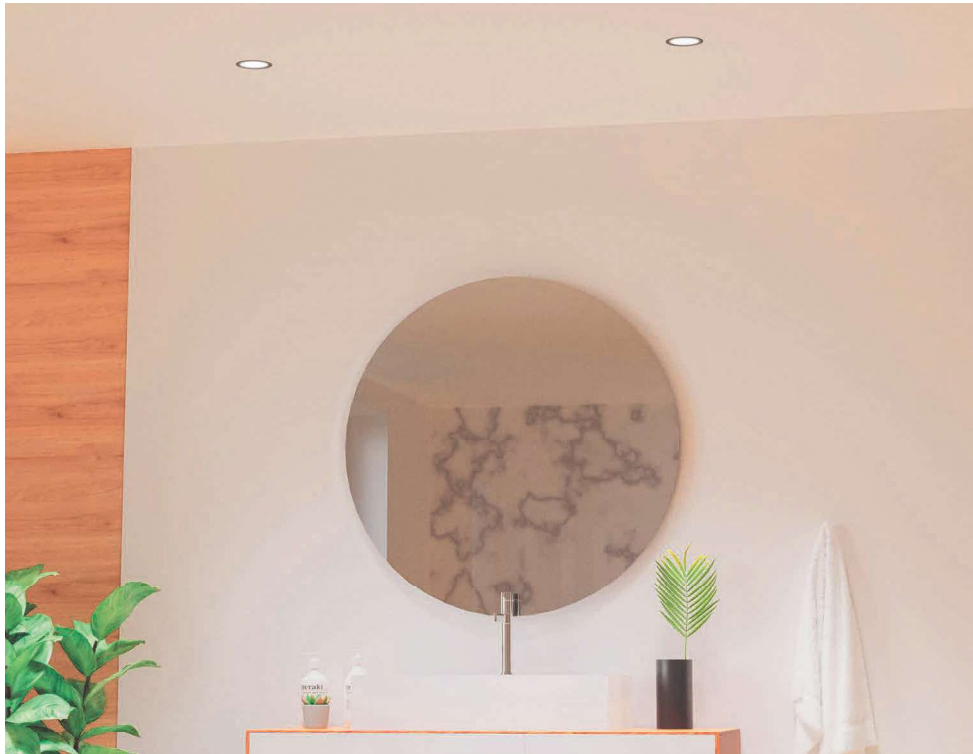

Code	Color	Power	Units
DE-0130-BLA	○ White	Max. 8W (LED)	50
DE-0130-NEG	● Black	Max. 8W (LED)	50



Bulb not included



Recessed downlight

Forlight

Feu

MAT
Aluminium

DIF
Glass

CLASS II
100-240V / 50-60Hz

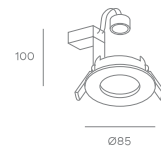

Ø71mm 0-20mm

Code	Color	Power	Units
DE-0129-CRO	● Chrome finish	Max. 8W (LED)	50
DE-0129-BLA	○ White	Max. 8W (LED)	50
DE-0129-NEG	● Black	Max. 8W (LED)	50



40 Bulb not included

Recessed downlight

Indoor Technical

Minor

MAT
Aluminium

DIF
Glass

CLASS II
100-240V / 50-60Hz

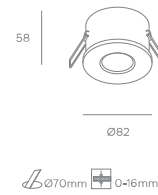

Code	Color	Power	Units
TC-1200-BLA S	○ White	Max. 8W (LED)	50



Bulb not included



IP 54

Rame

MAT
Aluminium

DIF
Glass

CLASS II
100-240V / 50-60Hz

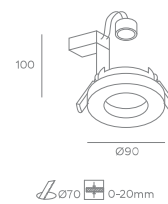

Code	Color	Power	Units
DE-0128-CRO S	● Chrome finish	Max. 8W (LED)	50



Bulb not included



IP 65

Modular downlight

Forlight

Mix LED

MAT
Aluminium

DIF
Glass

CLASS II
100-240VAC / 50-60Hz

TC-0070

TC-0071



Code	Size	Color	Power	Kelvin	Rated flux	Units
TC-0070-BLA	D58xH57mm	○ White matt	6,2W	3000K - 4000K - 5000K	900 lm*	16
TC-0070-NEG S	D58xH57mm	● Black	6,2W	3000K - 4000K - 5000K	900 lm*	16
TC-0071-BLA	D58xH96mm	○ White matt	11,2W	3000K - 4000K - 5000K	1624 lm*	20
TC-0071-NEG S	D58xH96mm	● Black	11,2W	3000K - 4000K - 5000K	1624 lm*	20

* Value based on 4000K.



TC-1900

TC-1901

TC-0111

TC-0476



The IP value corresponds to the entire luminaire (module + frame)

Code	Color	Short description	Units	Code	Color	Short description	Units
TC-1900-BLA	○ White matt	Round fixed	100	TC-1901-NEG S	● Black	Round adjustable	100
TC-1900-NEG S	● Black	Round fixed	100	TC-0111-BLA	○ White matt	Square fixed	100
TC-1901-BLA	○ White matt	Round adjustable	100	TC-0476-BLA	○ White matt	Round deep	100



TC-1900 + TC-0070 / TC-0071 / TC-0366

TC-1901 + TC-0070 / TC-0071 / TC-0366

TC-0111 + TC-0070 / TC-0071 / TC-0366

TC-0476 + TC-0070 / TC-0071 / TC-0366

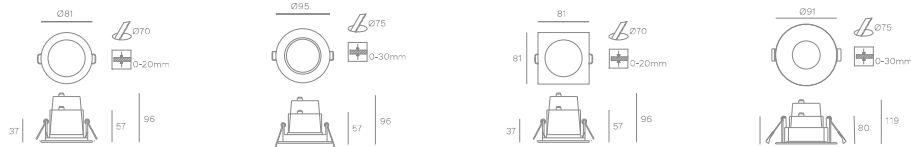

Modular downlight

Indoor Technical

Mix GU10

MAT
Aluminium

CLASS II
100-240VAC / 50-60Hz



Code	Color	Power	Units
TC-0366-BLA	○ White matt	Max. 8W (LED)	50
TC-0366-NEG S	● Black	Max. 8W (LED)	50



TC-0200

TC-0303

TC-0220

TC-0304**



The IP value corresponds to the entire luminaire (module + frame)

Code	Color	Short description	Units
TC-0200-BLA	○ White matt	Round visual comfort	100
TC-0303-BLA	○ White matt	Visual comfort adjust.	50
TC-0220-BLA	○ White matt	Round IP65	50

Code	Color	Short description	Units
TC-0220-NEG S	● Black	Round IP65	50
TC-0304-BLA** S	○ White matt	Surface	25

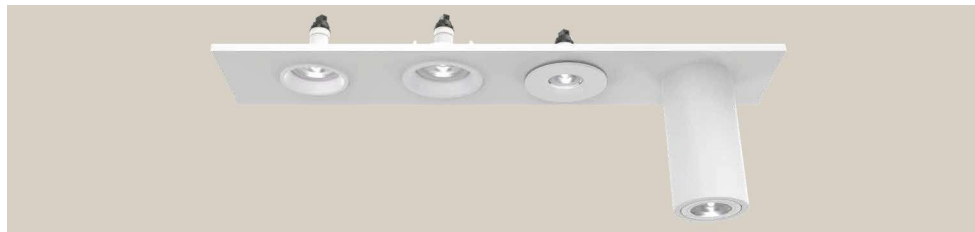

TC-0200 + TC-0070 / TC-0071 / TC-0366

TC-0303 + TC-0070 / TC-0071 / TC-0366

TC-0220 + TC-0070 / TC-0071 / TC-0366

TC-0304** + TC-0070 / TC-0366

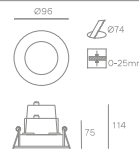
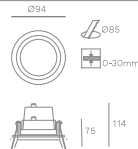
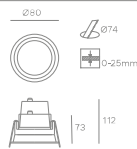

**Not compatible with TC-0071.

Surface downlight

Forlight

Jet NEW

MAT
Aluminium

DIF
Polystyrene

CLASS II
100-240V / 50-60Hz



TC-0251

TC-0252



74

∅118

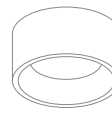

81

∅162

Jet collection

Recessed
downlight
P. 022



Code	Size	Color	Power	Kelvin	Rated flux	Units
TC-0251-BLA	D118xH74	○ White	10,9W	2700K - 3200K - 4000K	1574 lm*	20
TC-0251-NEG	D118xH74	● Black	10,9W	2700K - 3200K - 4000K	1574 lm*	20
TC-0252-BLA	D162xH81	○ White	20,8W	2700K - 3200K - 4000K	3004 lm*	20
TC-0252-NEG	D162xH81	● Black	20,8W	2700K - 3200K - 4000K	3004 lm*	20

*Value based on 3200K



Surface downlight

Indoor Technical



Surface downlight

Forlight

Easy

MAT
Aluminium

DIF
Acrylic

CLASS II
100-240V / 50-60Hz



TC-0160 / TC-0161

TC-0162 / TC-0163

TC-0415 / TC-0416

TC-0411 / TC-0412

35 |



Ø170

35 |



Ø225

35 |



Ø300

35 |



Ø400

Code	Size	Color	Power	Kelvin	Rated flux	Units
TC-0160-BLA	D170xH35mm	○ White	12,2W	3000K	1150 lm	20
TC-0161-BLA	D170xH35mm	○ White	12,2W	4000K	1150 lm	20
TC-0162-BLA	D225xH35mm	○ White	18,2W	3000K	1510 lm	20
TC-0163-BLA	D225xH35mm	○ White	18,2W	4000K	1510 lm	20
TC-0415-BLA	D300xH35mm	○ White	24W	3000K	2720 lm	10
TC-0416-BLA	D300xH35mm	○ White	24W	4000K	2720 lm	10
TC-0411-BLA	D400xH35mm	○ White	29,3W	3000K	3375 lm	5
TC-0412-BLA	D400xH35mm	○ White	29,3W	4000K	3375 lm	5



Surface downlight

Indoor Technical

MAT
Aluminium

DIF
Acrylic

CLASS II
100-240V / 50-60Hz



TC-0166 / TC-0167

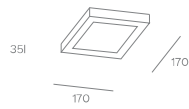

TC-0168 / TC-0169

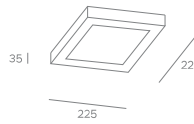

TC-0413 / TC-0414

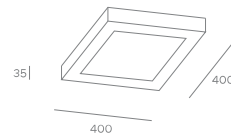

Code	Size	Color	Power	Kelvin	Rated flux	Units
TC-0166-BLA	L170xH35mm	○ White	12,2W	3000K	1150 lm	20
TC-0167-BLA	L170xH35mm	○ White	12,2W	4000K	1150 lm	20
TC-0168-BLA	L225xH35mm	○ White	18,2W	3000K	1510 lm	20
TC-0169-BLA	L225xH35mm	○ White	18,2W	4000K	1510 lm	20
TC-0413-BLA	L400xH35mm	○ White	29,3W	3000K	3813 lm	5
TC-0414-BLA	L400xH35mm	○ White	29,3W	4000K	4106 lm	5



Easy collection

Recessed
downlight
P. 024



Surface downlight

Forlight

Era NEW

STRUCT MAT
Aluminium

SHADE MAT
Aluminium

CLASS I
100-240V / 50-60Hz



TC-0248

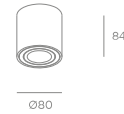

TC-0249

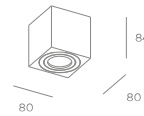

Code	Size	Color	Power	Units
TC-0248-NEG	D80xH84mm	● Black	Max. 8W (LED)	40
TC-0248-BLA	D80xH84mm	○ White	Max. 8W (LED)	40
TC-0249-NEG	D80xH84mm	● Black	Max. 8W (LED)	40
TC-0249-BLA	D80xH84mm	○ White	Max. 8W (LED)	40



48 Bulb not included

Era collection

Pendant lamp
P. 101



Spot series
P. 136



Reading light
P. 142



Surface downlight

Indoor Technical



Surface mounted

Forlight

Ilo

MAT
Aluminium

DIF
Polycarbonate

CLASS I
220-240V / 50-60Hz



TC-0235

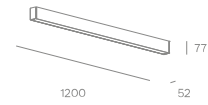

Suspension kit — TC-0237



Lineal union kit — TC-0240



Code	Size	Color	Power	Kelvin	Rated flux	Units
TC-0235-BLA	L1200xH80mm	○ White	26W	3000K - 4000K - 6000K	4064 lm*	6
TC-0235-NEG	L1200xH80mm	● Black	26W	3000K - 4000K - 6000K	4064 lm*	6

* Value based on 6000K

Accessory code	Color	Description	Units
TC-0237-BLA	○ White	Suspension kit	48
TC-0237-NEG	● Black	Suspension kit	48
TC-0240-SIN	-	Lineal union kit	150



Surface mounted

Indoor Technical

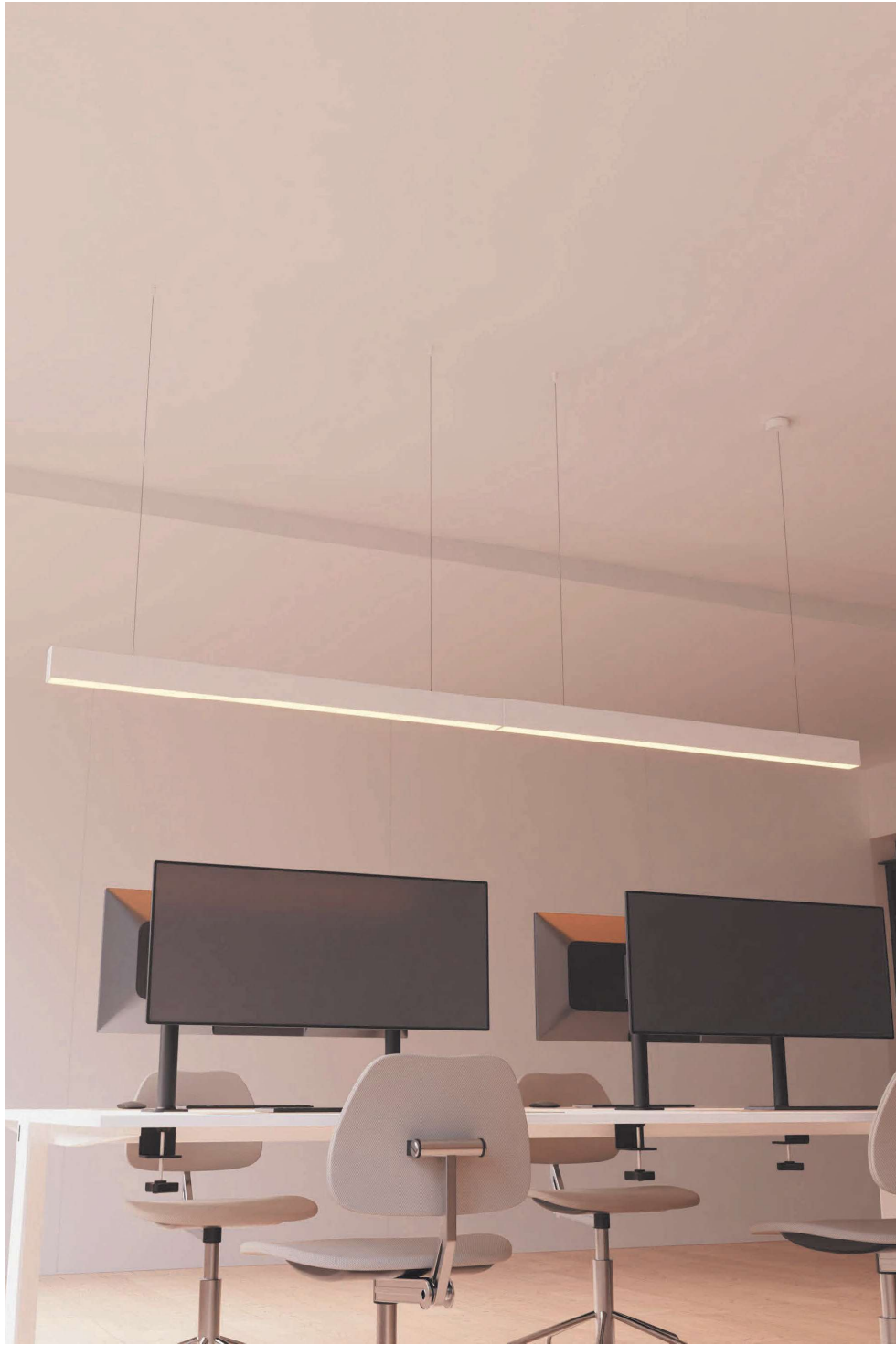

Surface mounted

Forlight

Pop NEW

MAT
ABS

DIF
Polycarbonate

CLASS II
220-240V / 50-60Hz



Installation with
quick connector



PX-0306



PX-0307 / PX-0769

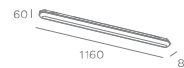

PX-0308

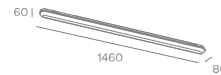

Code	Size	Color	Power	Kelvin	Rated flux	Units
PX-0306-GRI	L560xH60mm	● Grey	16,7W	4000K	2588 lm	15
PX-0307-GRI	L1160xH60mm	● Grey	35,4W	4000K	4879 lm	12
PX-0769-GRI N	L1160xH60mm	● Grey	37W	4000K	5100 lm	12
PX-0308-GRI	L1460xH60mm	● Grey	44W	4000K	6426 lm	8



PX-0769

LED panel

Indoor Technical

Square eco

MAT
Steel and Aluminium

DIF
Technopolymer

CLASS II
220-240V / 50-60Hz

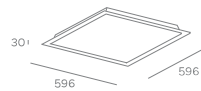

Directly replacing
armstrong ceiling units

Code	Color	Power	Kelvin	Rated flux	Units
TC-0075-BLA S	○ White	39W	4000K	4400 lm	4



Track spotlight

Forlight

Tent

NEW

MAT
Aluminium

DIF
Polycarbonate

CLASS II
220-240V / 50-60Hz

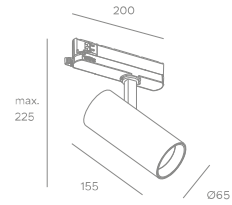

Compatible with triple Phase Track.

Code	Color	Power	Kelvin	Rated flux	Units
TC-0250-BLA	○ White	16W - 20W - 24W	2700K - 3200K - 4000K	3200 lm*	30
TC-0250-NEG	● Black	16W - 20W - 24W	2700K - 3200K - 4000K	3200 lm*	30

*Value based on 24W and 3200K.



TC-0046 / TC-0047

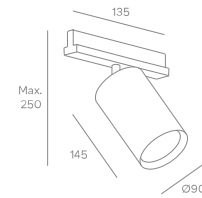

Compatible with triple Phase Track.

Code	Color	Power	Kelvin	Rated flux	Units
TC-0046-BLA S	○ White	27,5W	3000K	2930 lm	24
TC-0047-BLA S	○ White	27,5W	4000K	3110 lm	24
TC-0047-NEG S	● Black	27,5W	4000K	3110 lm	24

Two reflectors (spot and flood) included



Track spotlight

Indoor Technical



Track spotlight

Forlight

Luvo

MAT
Aluminum

CLASS I
100-240V / 50-60Hz

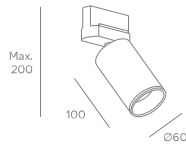

Compatible with triple Phase Track.

Code	Color	Power	Units
TC-0182-BLA	○ White	30W	50
TC-0182-NEG	● Black	30W	50



Track spotlight

Indoor Technical



Zilo NEW

STRUCT MAT
Aluminium

DIFF MAT
Glass

CLASS I
100-277V / 50-60Hz

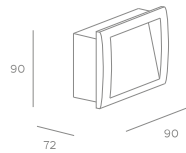

Code	Color	Power	Kelvin	Rated flux	Units
PX-0756-BLA	○ White	3,6W	2700K - 3200K - 4000K	465 lm*	50
PX-0756-GRI	● Grey	3,6W	2700K - 3200K - 4000K	465 lm*	50
PX-0756-NEG	● Black	3,6W	2700K - 3200K - 4000K	465 lm*	50

*Value based on 3200K



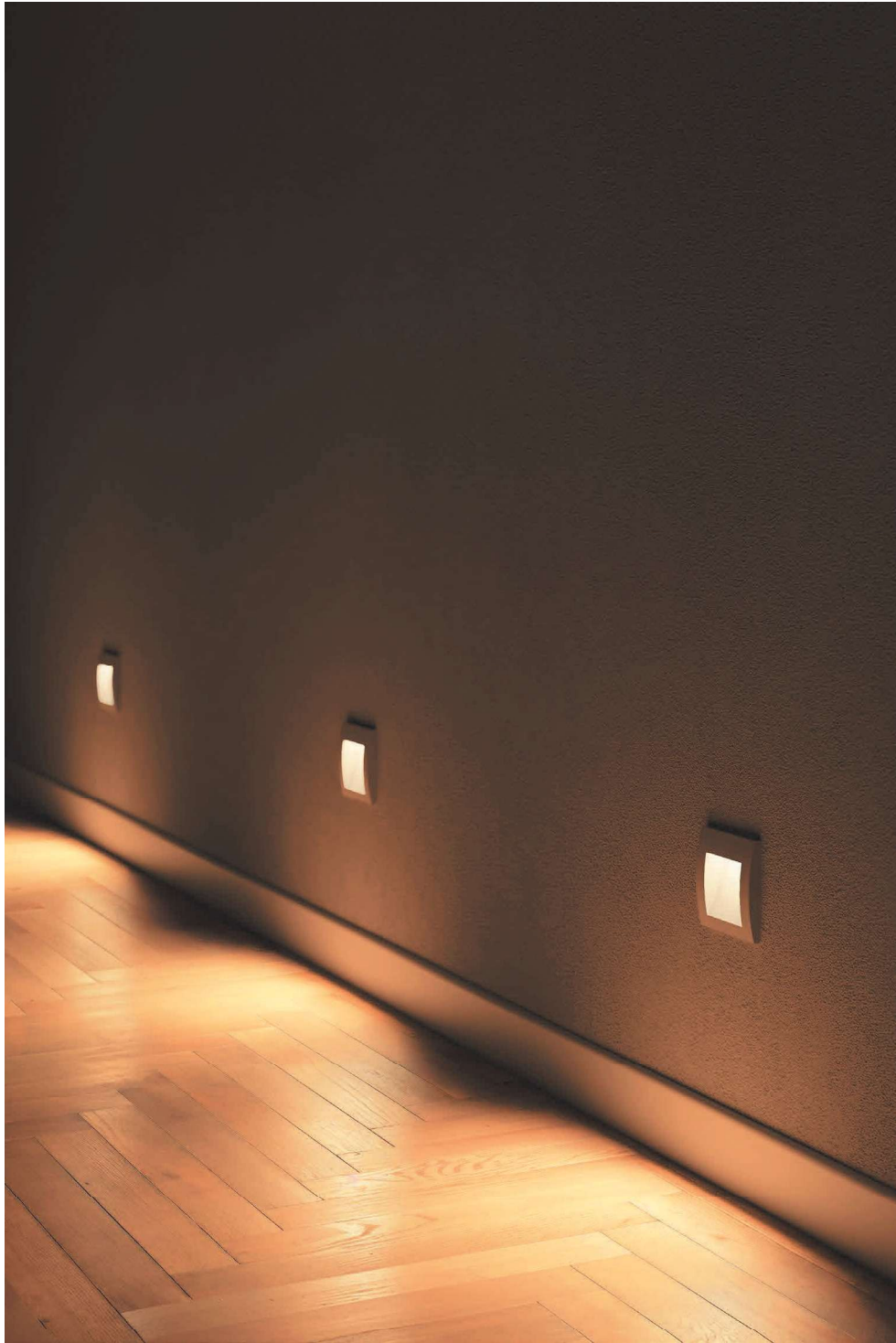

Senya NEW

STRUCT MAT
Aluminium

DIFF MAT
Polycarbonate

CLASS II
220-240V / 50-60Hz



PX-0370

PX-0371



Suitable for foot traffic.

Code	Color	Power	Kelvin	Rated flux	Units
PX-0370-BLA N	○ White	1,2W	3000K	92 lm	40
PX-0370-NEG N	● Black	1,2W	3000K	92 lm	40
PX-0370-ALU	● Aluminium	1,2W	3000K	92 lm	40
PX-0371-BLA N	○ White	2,2W	3000K	200 lm	20
PX-0371-NEG N	● Black	2,2W	3000K	200 lm	20
PX-0371-ALU	● Aluminium	2,2W	3000K	200 lm	20

Senya collection

Wayfinding
lighting
P.172



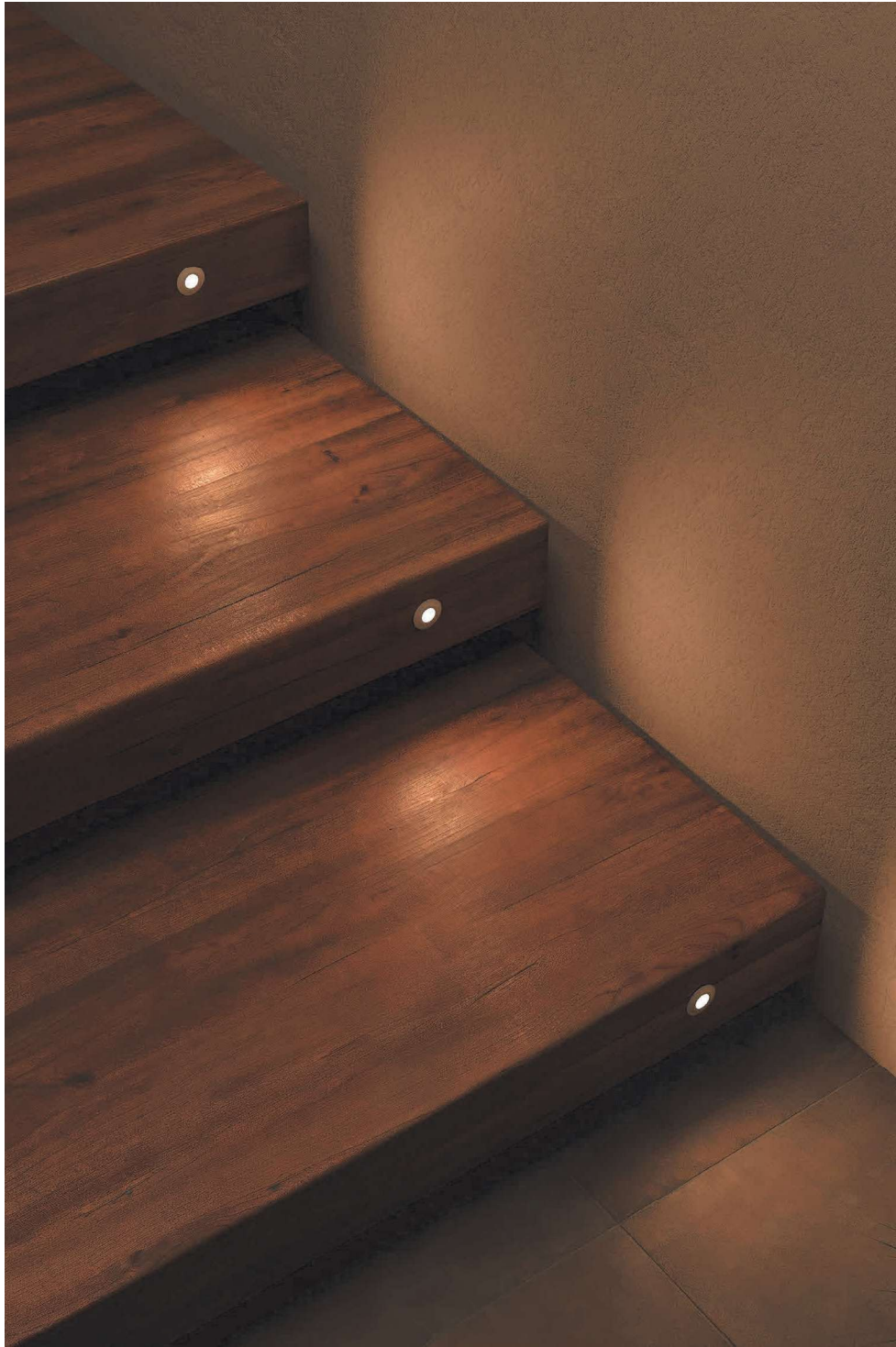

Icon

STRUCT MAT
Aluminium / Polycarbonate and ABS

DIFF MAT
Polycarbonate

CLASS I
220-240V / 50-60Hz



PX-0357

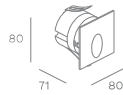

PX-0358



Code	Color	Power	Kelvin	Rated flux	Units
PX-0357-NEG	● Black	3,3W	3000K	228 lm	36
PX-0358-NEG	● Black	3,3W	3000K	228 lm	36



Nod

STRUCT MAT
Aluminium

DIFF MAT
Polycarbonate

CLASS I
220-240V / 50-60Hz



PX-0350



PX-0351



Code	Color	Power	Kelvin	Rated flux	Units
PX-0350-BLA	○ White	2,6W	3000K	210 lm	40
PX-0350-NEG	● Black	2,6W	3000K	210 lm	40
PX-0351-BLA	○ White	2,6W	3000K	210 lm	40
PX-0351-NEG	● Black	2,6W	3000K	210 lm	40



Passageway lighting

Indoor Technical

Kairo NEW

STRUCT MAT
ABS

DIFF MAT
Polycarbonate

CLASS II
100-240V / 50-60Hz



3 covers included



Code	Color	Power	Kelvin	Rated flux	Units
PX-0751-NEG	○ White / ● Grey / ● Black	2,9W	2700K - 3200K - 4000K	343 lm*	20

*Value based on 3200K



3 covers included



Code	Color	Power	Kelvin	Rated flux	Units
PX-0755-NEG	○ White / ● Grey / ● Black	4W	2700K - 3200K - 4000K	711 lm*	20

*Value based on 3200K



Downlight de superficie
Surface downlight
Downlight surface

Fab 066

Downlight empotrado
Recessed downlight
Downlight encastré

Ter 068

Rame 070

Minor 070

Lab 071

Feu 071

Applique pared
Wall lamp
Applique

Sfera 072

Giro 074

Metà 075

Passaggio 076

Nora 078

Lungo 079

Espejo
Mirror
Miroir

Lizz 080

Zico 082



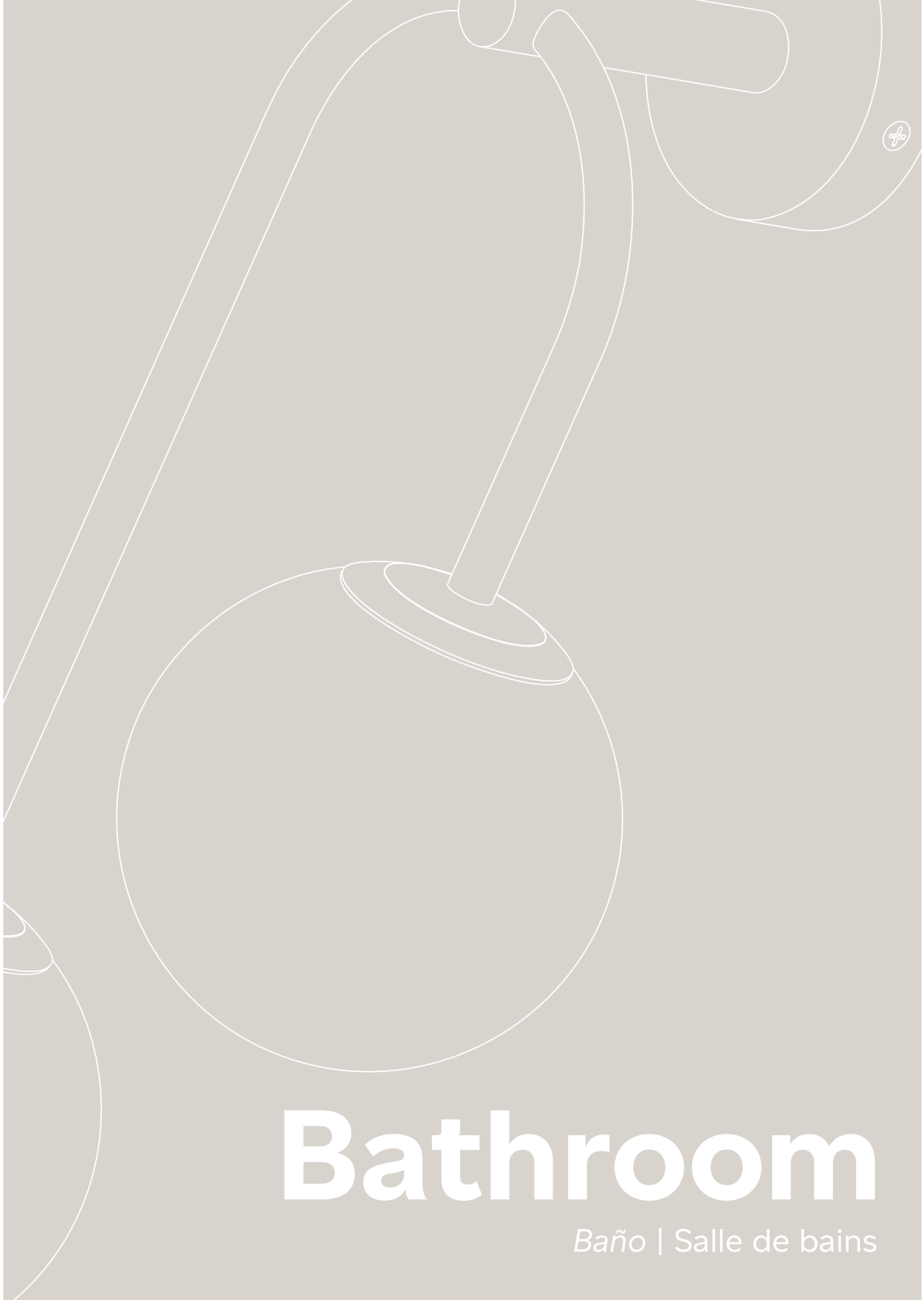

Bathroom

Baño | Salle de bains

Surface downlight

Forlight

Fab

MAT
Aluminium

DIF
Glass

CLASS II
100-240V / 50-60Hz

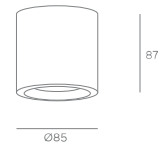

Code	Color	Power	Units
DE-0131-BLA	○ White	Max. 8W (LED)	50
DE-0131-NEG	● Black	Max. 8W (LED)	50



66
Bulb not included

Surface downlight

Bathroom

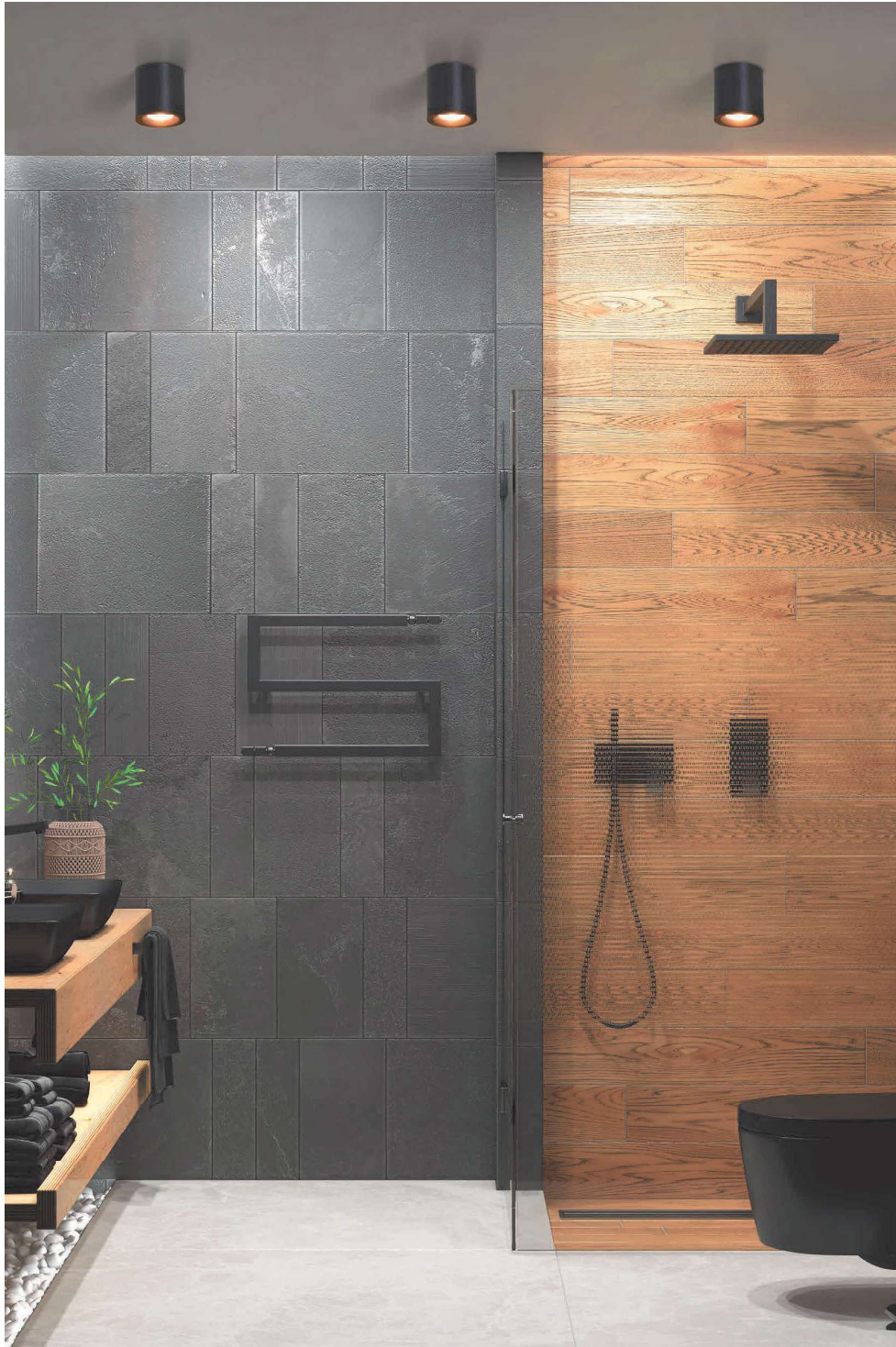

Recessed downlight

Forlight

Ter

MAT
Aluminium

DIF
Glass

CLASS II
100-240V / 50-60Hz

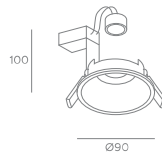

Ø78 0-20mm

Code	Color	Power	Units
DE-0130-BLA	○ White	Max. 8W (LED)	50
DE-0130-NEG	● Black	Max. 8W (LED)	50



68 Bulb not included

Recessed downlight

Bathroom

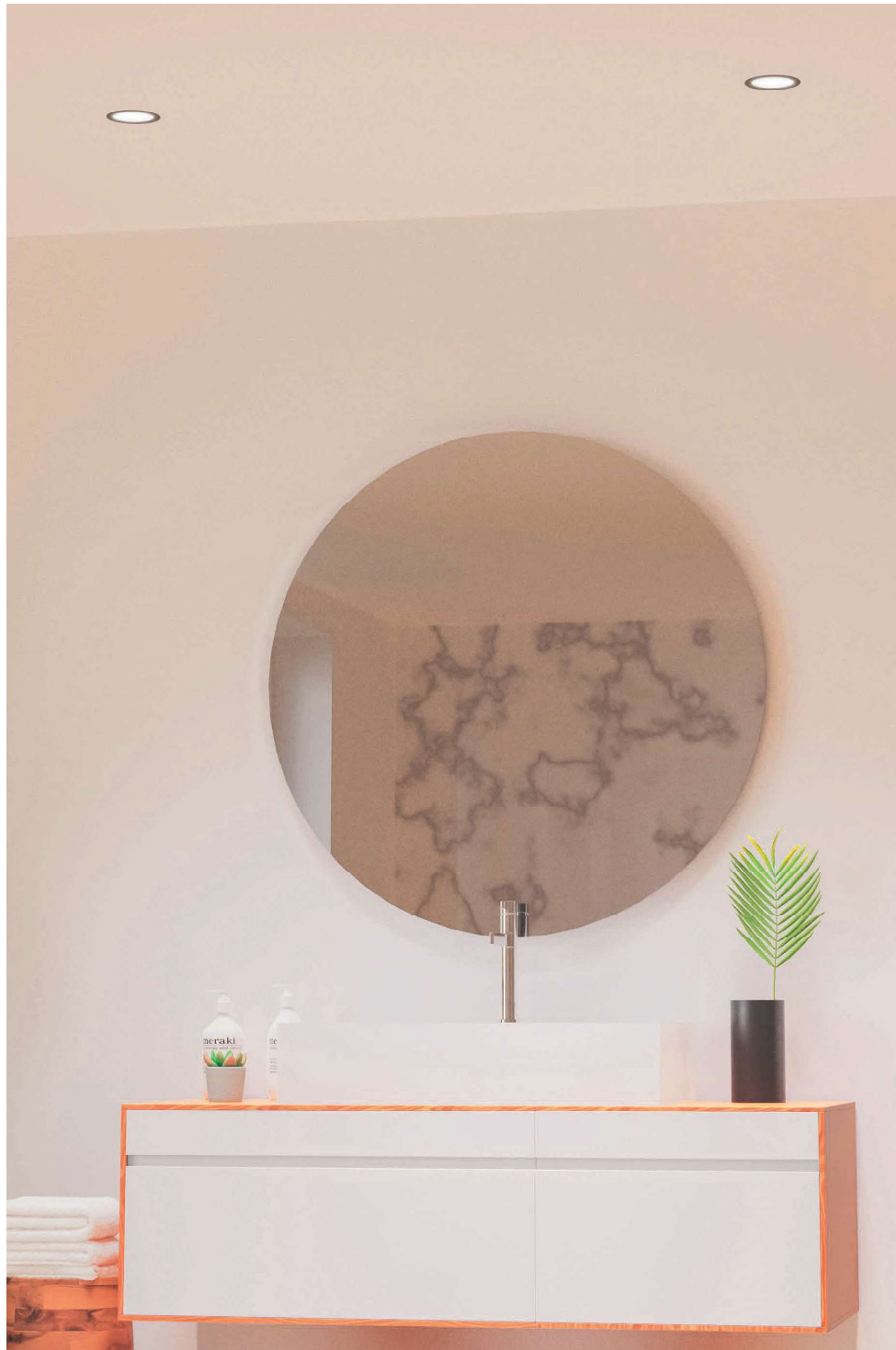

Recessed downlight

Forlight

Rame

MAT
Aluminium

DIF
Glass

CLASS II
100-240V / 50-60Hz

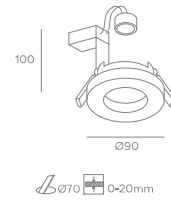

Code	Color	Power	Units
DE-0128-CRO S	● Chrome finish	Max. 8W (LED)	50



Bulb not included



Minor

MAT
Aluminium

DIF
Glass

CLASS II
100-240V / 50-60Hz

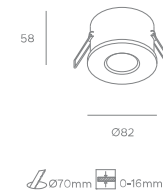

Code	Color	Power	Units
TC-1200-BLA S	○ White	Max. 8W (LED)	50



Bulb not included



Recessed downlight

Bathroom

Lab

MAT
Steel

DIF
Glass

CLASS II
100-240V / 50-60Hz

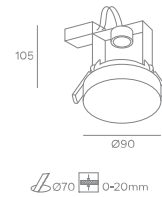

Code	Color	Power	Units
DE-0132-BLA	○ White finish	Max. 8W (LED)	50



Bulb not included



IP 65

Feu

MAT
Aluminium

DIF
Glass

CLASS II
100-240V / 50-60Hz



Code	Color	Power	Units
DE-0129-CRO	● Chrome finish	Max. 8W (LED)	50
DE-0129-BLA	○ White	Max. 8W (LED)	50
DE-0129-NEG	● Black	Max. 8W (LED)	50



Bulb not included



IP 65

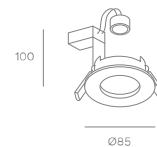

∅71mm + 0-20mm

Wall lamp

Forlight

Sfera

MAT
Steel

DIF
Glass

CLASS II
100-240V / 50-60Hz



DE-0237

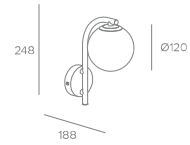

DE-0238

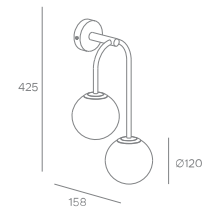

DE-0240

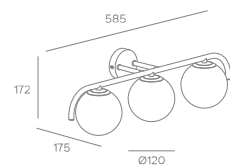

Code	Color	Power	Units
DE-0237-NEG	● Black	Max 6W (LED)	12
DE-0238-NEG	● Black	2xMax 6W (LED)	6
DE-0240-NEG	● Black	3xMax 6W (LED)	4



Bulb not included



IP 44

Wall lamp

Bathroom



Wall lamp

Forlight

Giro

MAT
Steel

DIF
Glass

CLASS II
100-240V / 50-60Hz



DE-0127: 100-240V / 50-60Hz

DE-0133: 220-240V / 50-60Hz

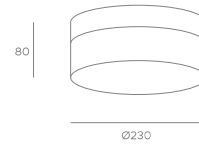
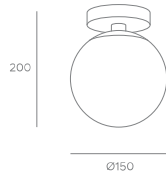

Code	Color	Power	Kelvin	Rated flux	Units
DE-0127-NEG	● Black	Max. 9W (LED)	-	-	8
DE-0133-NEG	● Black	11,2W	3000K - 4000K	1487 lm*	6

* Value based on 4000K

DE-127 DE-133

IP 44 E14 Bulb not included LED INCLUDED 36.000 HOURS CCT SWITCH (LED)

Wall lamp

Bathroom

Metà

MAT
Aluminium

DIF
Glass

CLASS II
100-240V / 50-60Hz

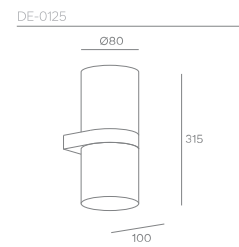
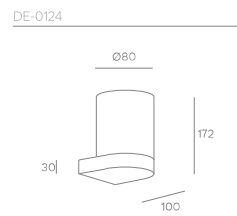

Code	Size	Color	Power	Units
DE-0124-NEG	H172xD80mm	● Black	Max. 8W (LED)	12
DE-0125-NEG	H315xD80mm	● Black	2x Max. 8W (LED)	8



Bulb not included



IP-44

Wall lamp

Forlight

Passeggio

MAT
Aluminium

DIF
Silicone

CLASS II
220-240V / 50-60Hz

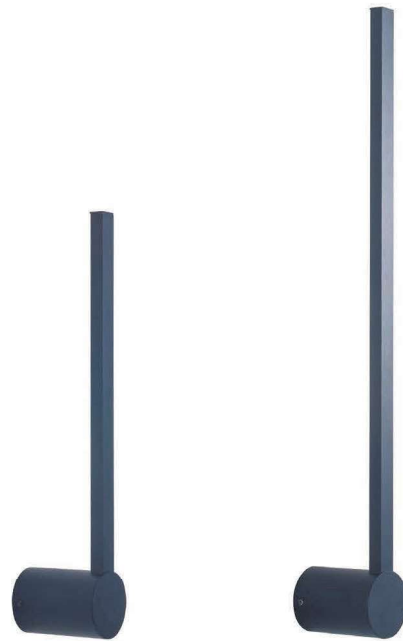

DE-0241

DE-0242

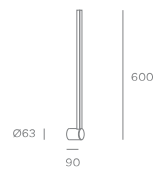
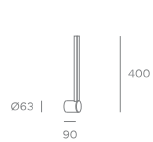

Code	Size	Color	Power	Kelvin	Rated flux	Units
DE-0241-NEG	H400mm	● Black	7W	4000K	602 lm	12
DE-0242-NEG	H600mm	● Black	11W	4000K	1320 lm	12



Wall lamp

Bathroom



Wall lamp

Forlight

Nora

MAT
Aluminium

DIF
Polycarbonate

CLASS II
220-240V / 50-60Hz

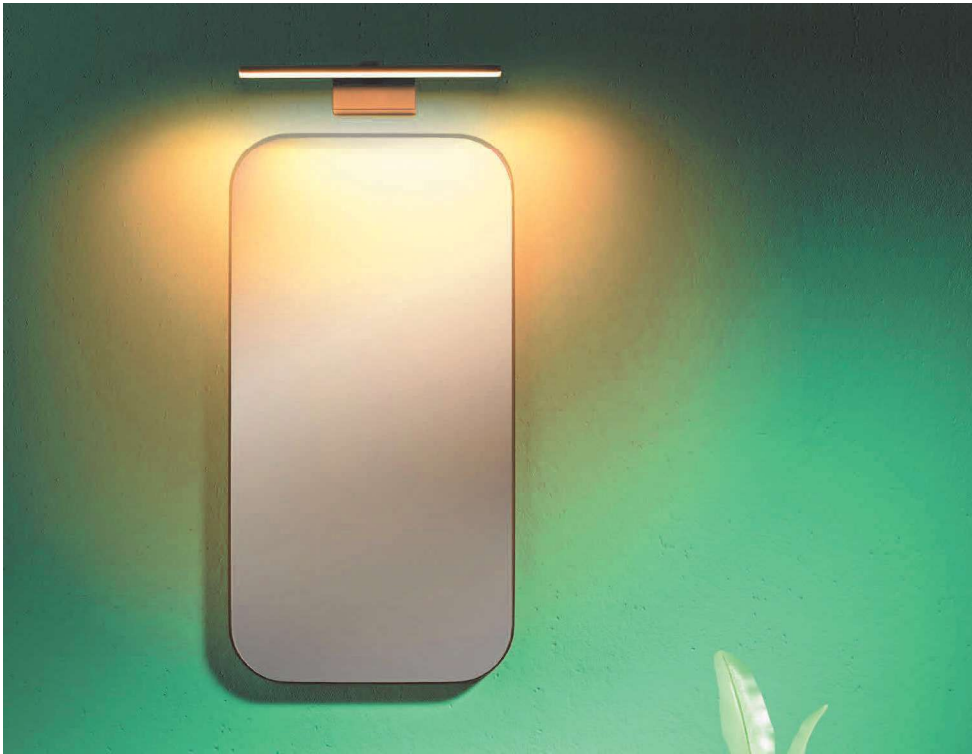

DE-0121

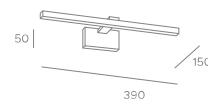

DE-0122

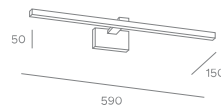

Code	Size	Color	Power	Kelvin	Rated flux	Units
DE-0121-NEG	L390xH50mm	● Black	8,3W	4000K	936 lm	10
DE-0122-NEG	L590xH50mm	● Black	13,5W	4000K	1512 lm	10



Wall lamp

Bathroom

Lungo

MAT
Steel

DIF
Polycarbonate

CLASS II
100-240V / 50-60Hz



DE-0428

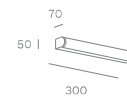

DE-0429

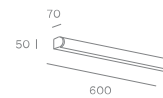

Code	Size	Color	Power	Kelvin	Rated flux	Units
DE-0428-CRO	L300x70mm	● Chrome finish	9,3W	3000K	910 lm	18
DE-0429-CRO	L600x70mm	● Chrome finish	13,5W	3000K	1365 lm	12



Mirror

Forlight

Lizz

MAT
Glass + iron

CLASS II
220-240V / 50-60Hz



DE-0176

DE-0177

DE-0178

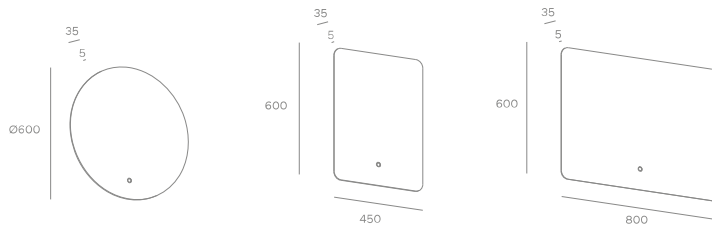

Code	Size	Power	Kelvin	Rated flux	Units
DE-0176-ESP	D600mm	21W	4000K	2610 lm	1
DE-0177-ESP	L450xH600mm	21W	4000K	2610 lm	1
DE-0178-ESP	L800xH600mm	29W	4000K	3604 lm	1





Mirror

Forlight

Zico

MAT
Glass + iron

CLASS II
220-240V / 50-60Hz



DE-0217

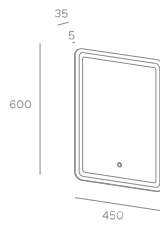

DE-0218

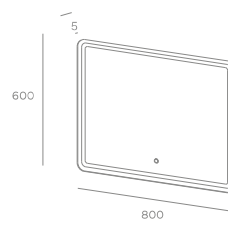

Code	Size	Power	Kelvin	Rated flux	Units
DE-0217-ESP	L450xH600mm	21W	4000K	2610 lm	1
DE-0218-ESP	L800xH600mm	29W	4000K	3604 lm	1



Mirror

Bathroom



Colgante
Pendant lamp
Suspension

Cortic	090
Dama	092
Riba	094
Viva	095
Stac	N 096
Fres	098
Nube	100
Era	101

Aplique pared
Wall lamp
Applique

Duplo	N 102
Meds	104
Fres	106
Thin	108
Keop	108
Toppi	109
Ander	110
Glass	111
Niza	111

Sobremesa
Table Lamp
Lampes de table

Cortic	112
Viva	114
Fres	116
Nuts	118
Meds	120
Ding	121
Touch	122
Zenit	123

Pie de salón
Floor lamp
Lampadaires

Viva	124
Fres	126
Meds	128
Ding	129

Luminaria de superficie
Surface mounted
Luminaire de surface

Stac	N 130
Farrow	132

Serie de focos
Spot series
Séries de spots

Kaplan	N 134
Era	136
Nature	138
Eufo	140

Luz de lectura
Reading light
Lampe de lecture

Era	142
Colo	143
Crobat	144
Mine	145
Bas	146
Lyon	147
Aura	148
Janet	149

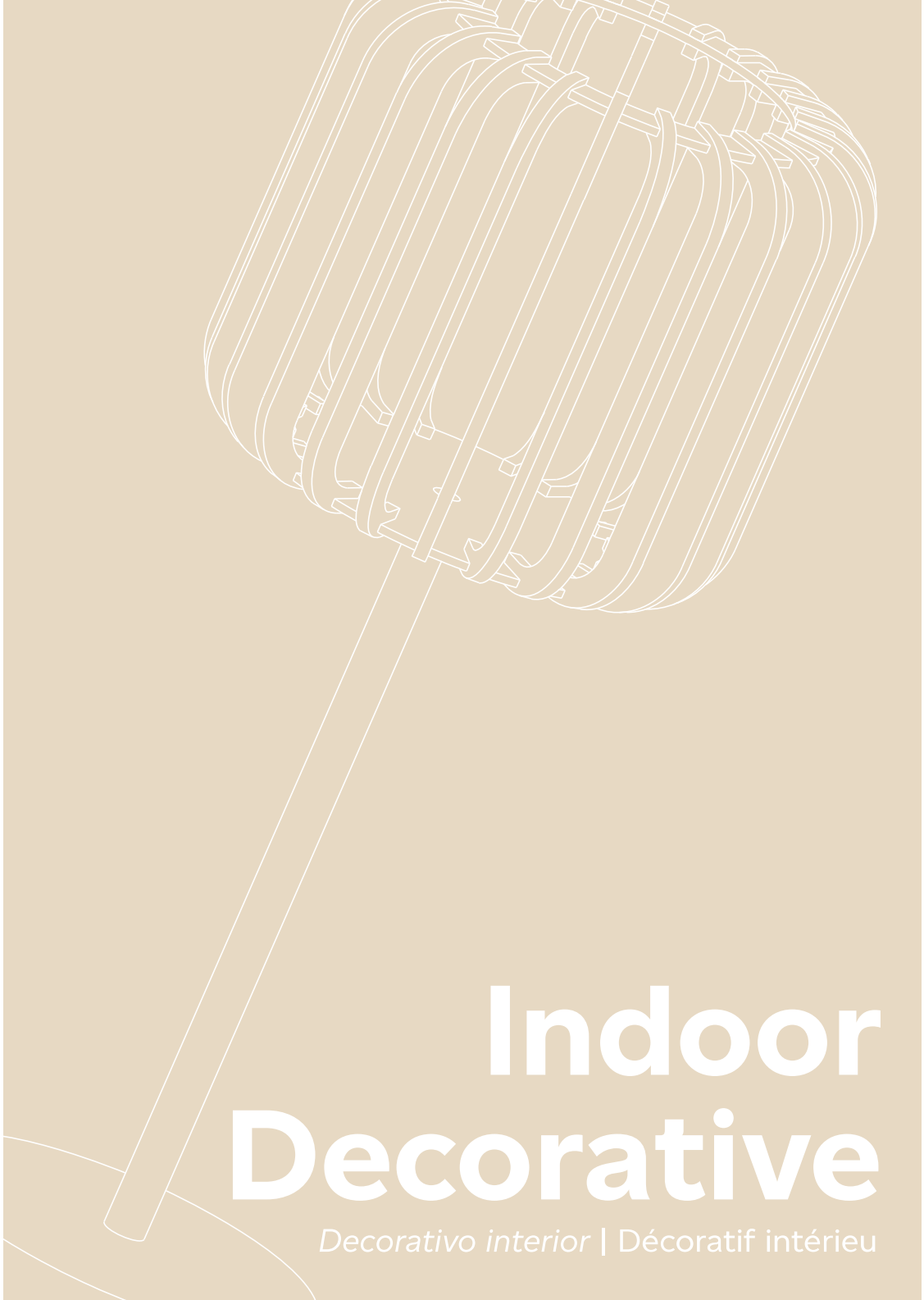

Indoor Decorative

Decorativo interior | Décoratif intérieur









Pendant lamp

Forlight

Cortic

STRUCT MAT
Steel

SHADE MAT
FSC rattan

CLASS I
100-240V / 50-60Hz



DE-0213

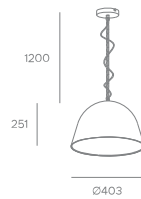

DE-0214



Code	Color	Power	Units
DE-0213-NAT	● Light wood	Max. 15W (LED)	1
DE-0214-NAT	● Dark wood	Max. 15W (LED)	1

Cortic collection

Table lamp
P. 112



90 Bulb not included

Pendant lamp

Indoor Decorative



Pendant lamp

Forlight

Dama

STRUCT MAT
Steel

SHADE MAT
FSC paper

CLASS I
100-240V / 50-60Hz



Code	Color	Power	Units
DE-0236-NAT	● Natural	Max. 15W (LED)	1



92

Bulb not included



Pendant lamp

Indoor Decorative



Pendant lamp

Forlight

Riba

STRUCT MAT
Steel

SHADE MAT
Wood

CLASS I
100-240V / 50-60Hz



DE-0023

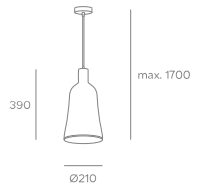

DE-0024



Code	Color	Power	Units
DE-0023-NEG	● Light wood	Max. 15W (LED)	1
DE-0024-NEG	● Light wood	Max. 15W (LED)	1



Bulb not included

Pendant lamp

Indoor Decorative

Viva

STRUCT MAT
Steel

SHADE MAT
FSC Wood

DIFF MAT
Textile

CLASS I
100-240V / 50-60Hz

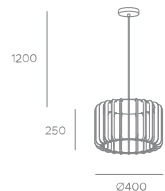

Viva collection

Table lamp
P. 114



Floor lamp
P. 124



Code	Color	Power	Units
DE-0179-NAT	● Light wood	Max. 15W (LED)	1



Bulb not included



Pendant lamp

Forlight

Stac NEW

STRUCT MAT
Steel

DIFF MAT
Polystyrene

CLASS I
220-240V / 50-60Hz



DE-0287 + DE-0289

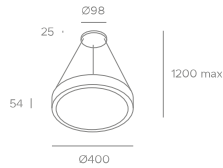

DE-0288 + DE-0289

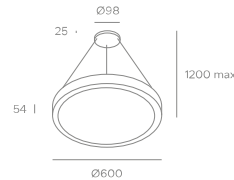

Code	Size	Color	Power	Kelvin	Rated flux	Units
DE-0287-BLA	D400m	○ White	25W	2700K - 3200K - 4000K	3240 lm*	10
DE-0287-NEG	D400m	● Black	25W	2700K - 3200K - 4000K	3240 lm*	10
DE-0288-BLA	D600m	○ White	40W	2700K - 3200K - 4000K	5700 lm*	5
DE-0288-NEG	D600m	● Black	40W	2700K - 3200K - 4000K	5700 lm*	5

* Value based on 3200K.

Not included	Code	Size	Description
	DE-0289-BLA	1200mm	○ White hanging wire kit
	DE-0289-NEG	1200mm	● Black hanging wire kit

Stac collection



Surface mounted
P. 130



Pendant lamp

Indoor Decorative



Pendant lamp

Forlight

Fres

STRUCT MAT
Steel

SHADE MAT
Steel

CLASS I
100-240V / 50-60Hz



Fres collection

Wall lamp
P. 106



Table lamp
P. 116



Floor lamp
P. 126



Code	Color	Power	Units
DE-0248-BEI	● Beige	Max. 15W (LED)	1



Pendant lamp

Indoor Decorative



Pendant lamp

Forlight

Nube

STRUCT MAT
Steel and wood

SHADE MAT
Steel

CLASS I
100-240V / 50-60Hz

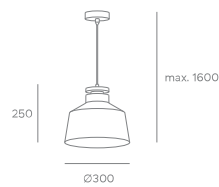

Code	Color	Power	Units
DE-0233-BLA S	○ White	Max. 15W (LED)	4



100
Bulb not included

Pendant lamp

Indoor Decorative

Era

STRUCT MAT
Aluminium

SHADE MAT
Aluminium

CLASS I
100-240V / 50-60Hz

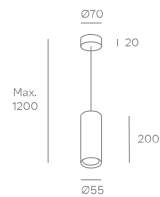

Era collection

Spot series
P. 136



Reading light
P. 142



Surface
downlight
P. 048



Code	Color	Power	Units
TC-0079-BLA	○ White	Max. 8W (LED)	30
TC-0079-NEG	● Black	Max. 8W (LED)	30



Wall lamp

Forlight

Duplo NEW

STRUCT MAT
Aluminium

CLASS I
100-240V / 50-60Hz

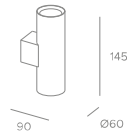

Code	Color	Power	Units
DE-0290-BLA	○ White	2 x max. 8W (LED)	40
DE-0290-NEG	● Black	2 x max. 8W (LED)	40



Bulb not included

Wall lamp

Indoor Decorative



Wall lamp

Forlight

Meds

STRUCT MAT
Aluminium

CLASS I
100-240V / 50-60Hz

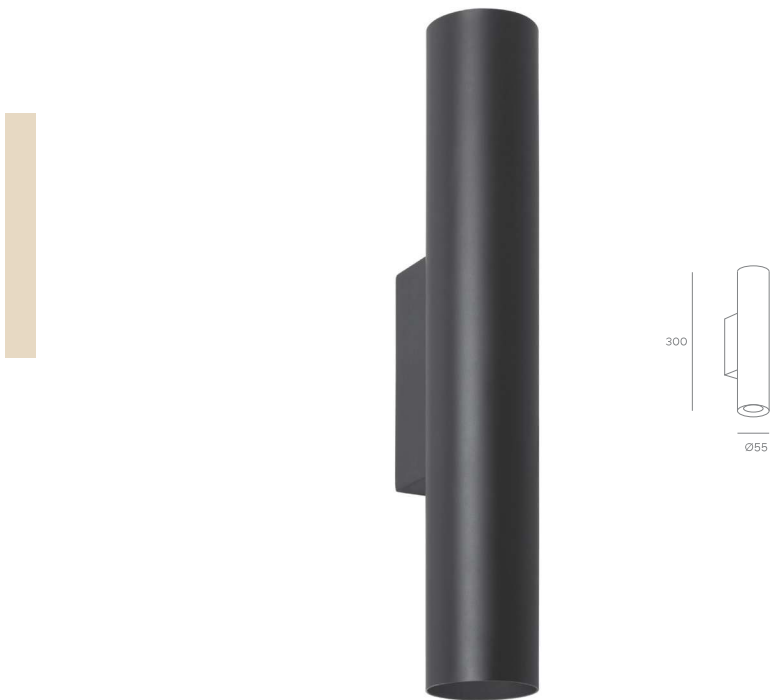

Meds collection

Table lamp
P. 120



Floor lamp
P. 128



Code	Color	Power	Units
DE-0136-NEG	● Black	2x Max. 8W (LED)	20



104
Bulb not included

Wall lamp

Indoor Decorative



Wall lamp

Forlight

Fres

STRUCT MAT
Steel

SHADE MAT
Aluminum

CLASS I
100-240V / 50-60Hz



Fres collection

Pendant lamp
P. 098



Table lamp
P. 116



Floor lamp
P. 126



Code	Color	Power	Units
DE-0247-BEI	● Beige	Max. 9W (LED)	4
DE-0247-AZU	● Ultramarine blue	Max. 9W (LED)	4
DE-0247-NAR	● Salmon orange	Max. 9W (LED)	4
DE-0247-VER	● Reed green	Max. 9W (LED)	4



Wall lamp

Indoor Decorative



Wall lamp

Forlight

Thin

STRUCT MAT
Aluminium

DIFF MAT
Acrylic

CLASS II
220-240V / 50-60Hz

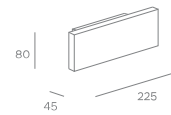

Code	Color	Power	Kelvin	Rated flux	Units
DE-0509-BLA	○ White	7,8W	3000K	860 lm	10
DE-0509-NEG	● Black	7,8W	3000K	860 lm	10



Keep

STRUCT MAT
Aluminium

CLASS I
100-277V / 50-60Hz

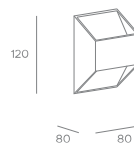

Code	Color	Power	Kelvin	Rated flux	Units
DE-0229-BLA	○ White	5,8W	3000K	420 lm	20



Wall lamp

Indoor Decorative

Toppi

STRUCT MAT
Aluminium

CLASS I / CLASS II
100-240V / 50-60Hz



DE-0231 / Classe II

DE-0232 / Classe I

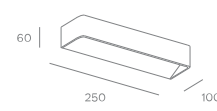
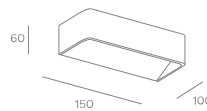

Code	Color	Power	Kelvin	Rated flux	Units
DE-0231-BLA	○ White	5,8W	3000K	530 lm	20
DE-0232-BLA	○ White	11,5W	3000K	1100 lm	20



Wall lamp

Forlight

Ander

STRUCT MAT
Aluminium and Steel

DIFF MAT
Acrylic

CLASS II
220-240V / 50-60Hz

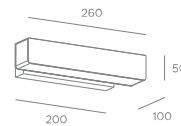

Code	Color	Power	Kelvin	Rated flux	Units
DE-0123-BLA S	○ White	6,6W	3000K	720 lm	20



Wall lamp

Indoor Decorative

Glass

STRUCT MAT
Steel

DIFF MAT
Glass

CLASS I
100-240V / 50-60Hz



DE-0000

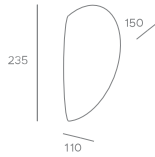

DE-0001

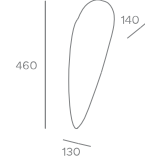

Code	Color	Power	Units
DE-0000-BLA	○ White	Max. 15W (LED)	6
DE-0001-BLA	○ White	Max. 15W (LED)	6



Niza

STRUCT MAT
Steel

DIFF MAT
Glass

CLASS I
100-240V / 50-60Hz

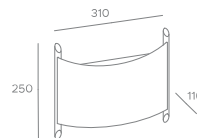

Code	Color	Power	Units
DE-0004-SAT	● Satin nickel	2x Max. 15W (LED)	6



Bulb not included

Table Lamp

Forlight

Cortic

STRUCT MAT
Steel

SHADE MAT
FSC rattan

CLASS II
100-240V / 50-60Hz



Cortic collection

Pendant lamp
P. 090



Code	Color	Power	Units
DE-0215-NAT	● Light wood	Max. 15W (LED)	1



112
Bulb not included

Table Lamp

Indoor Decorative



Table Lamp

Forlight

Viva

STRUCT MAT
Steel

SHADE MAT
FSC wood

DIFF MAT
Textile

CLASS II
100-240V / 50-60Hz



Code	Color	Power	Units
DE-0200-NAT	● Light wood	Max. 15W (LED)	1



Bulb not included



Viva collection



Table Lamp

Indoor Decorative



Table Lamp

Forlight

Fres

STRUCT MAT
Steel

SHADE MAT
Steel

CLASS II
100-240V / 50-60Hz



Fres collection

Pendant lamp
P. 098



Wall lamp
P. 106



Floor lamp
P. 126



Code	Color	Power	Units
DE-0250-BEI	● Beige	Max. 15W (LED)	1



Bulb not included



Table Lamp

Indoor Decorative



Table Lamp

Forlight

Nuts

STRUCT MAT
FSC wood

SHADE MAT
Textile

DIFF MAT
Textile

CLASS II
100-240V / 50-60Hz

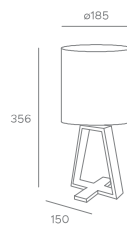

Code	Color	Structure color	Power	Units
DE-0020-BLA	○ White	● Natural wood	Max. 15W (LED)	12
DE-0020-GR1	● Grey	● Natural wood	Max. 15W (LED)	12



118 Bulb not included

Table Lamp

Indoor Decorative



Table Lamp

Forlight

Meds

STRUCT MAT
Aluminium

CLASS II
100-240V / 50-60Hz



Meds collection

Wall lamp
P. 104



Floor lamp
P. 128



Code	Color	Power	Units
DE-0134-NEG	● Black	Max. 8W (LED)	4



120
Bulb not included

Table Lamp

Indoor Decorative

Ding

STRUCT MAT
Aluminium

DIFF MAT
Polycarbonate

CLASS II
100-240V / 50-60Hz

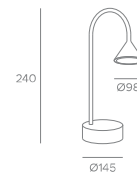

Code	Color	Power	Kelvin	Rated flux	Units
DE-0271-BLA S	○ White	6,6W	3000K	520 lm	6
DE-0271-NEG S	● Black	6,6W	3000K	520 lm	6



Ding collection

Floor lamp
P. 129



Table Lamp

Forlight

Touch

STRUCT STRUCT MAT
Aluminium

DIFF MAT
Polycarbonate

CLASS II
100-240V / 50-60Hz



Code	Color	Power	Kelvin	Rated flux	Units
DE-0477-BLA	○ White	6,4W	3000K - 6500K	680 lm	6



Table Lamp

Indoor Decorative

Zenit

STRUCT MAT
ABS

DIFF MAT
Polycarbonate

CLASS II
220-240V / 50-60Hz

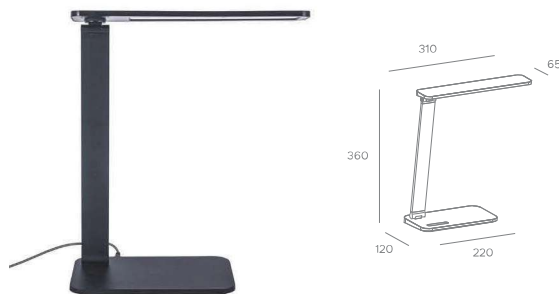

Code	Color	Power	Kelvin	Rated flux	Units
DE-0175-NEG	● Black	7,2W	3000K - 4000K - 6500K	690 lm*	8

* Value based on 4000K.



Floor lamp

Forlight

Viva

STRUCT MAT
Steel

SHADE MAT
FSC wood

DIFF MAT
Textile

CLASS II
100-240V / 50-60Hz



Viva collection



Code	Color	Power	Units
DE-0201-NAT	● Light wood	Max. 15W (LED)	1



Bulb not included



Floor lamp

Indoor Decorative



Floor lamp

Forlight

Fres

STRUCT MAT
Steel

SHADE MAT
Aluminum

CLASS II
100-240V/50-60Hz

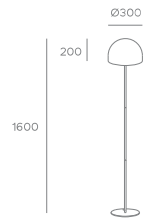

Fres collection

Pendant lamp
P. 098



Wall lamp
P. 106



Table lamp
P. 116



Code	Color	Power	Units
DE-0249-BEI	● Beige	Max. 15W (LED)	1
DE-0249-VER	● Reed green	Max. 15W (LED)	1
DE-0249-ROJ	● Brown red	Max. 15W (LED)	1



Bulb not included



Floor lamp

Indoor Decorative

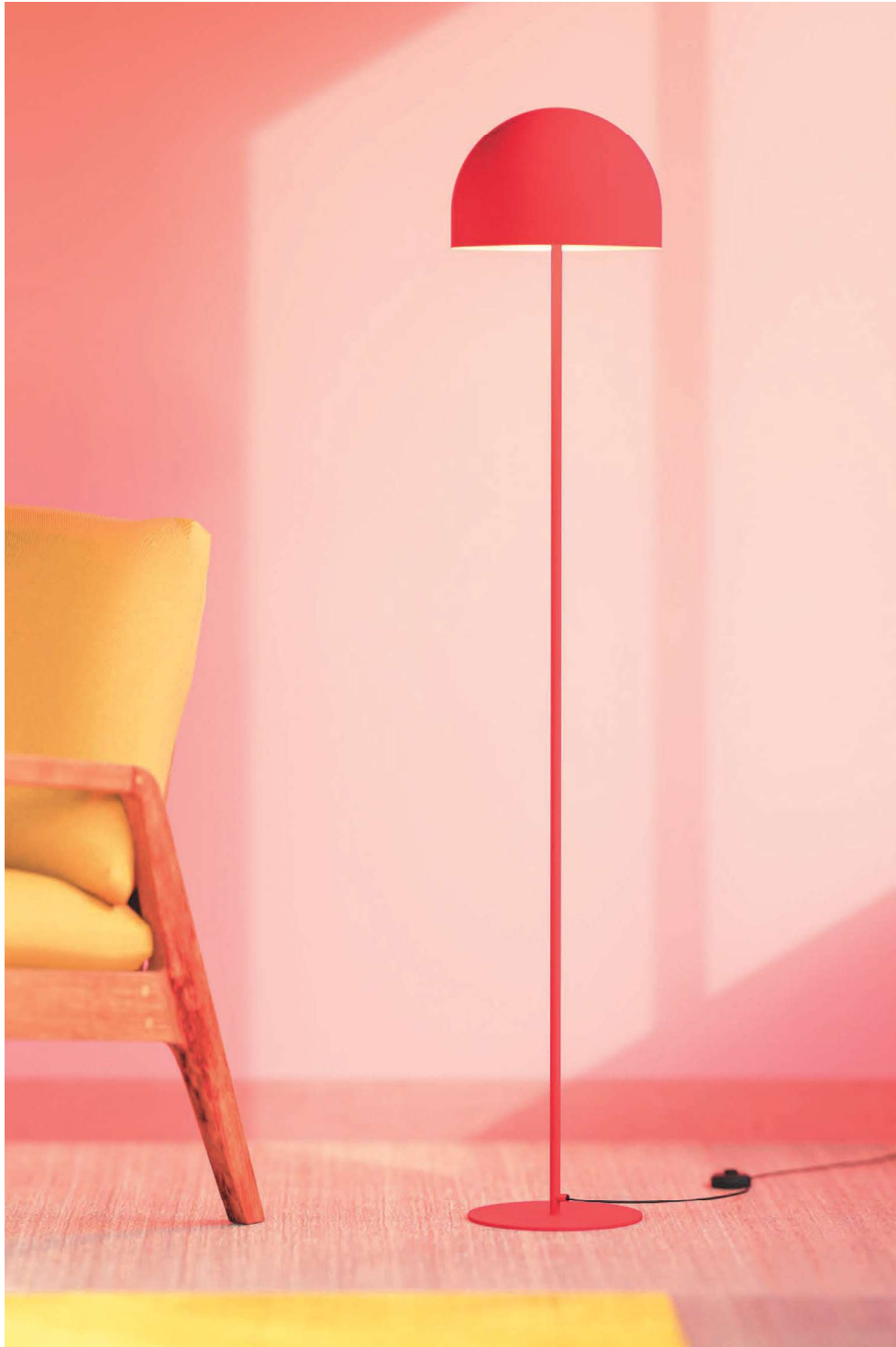

Floor lamp

Forlight

Meds

STRUCT MAT
Aluminium

CLASS II
100-240V / 50-60Hz



Meds collection

Wall lamp
P. 104



Table lamp
P. 120



Code	Color	Power	Units
DE-0135-NEG	● Black	Max. 8W (LED)	4



128
Bulb not included

Floor lamp

Indoor Decorative

Ding

STRUCT MAT
Aluminium and steel

DIFF MAT
Polycarbonate

CLASS II
100-240V / 50-60Hz

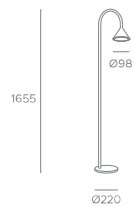

Ding collection

Table lamp
P, 121



Code	Color	Power	Kelvin	Rated flux	Units
DE-0272-BLA S	○ White	6,6W	3000K	520 lm	4



Surface mounted

Forlight

Stac NEW

STRUCT MAT
Steel

DIFF MAT
Polystyrene

CLASS I
220-240V / 50-60Hz



TC-0105 / DE-0287

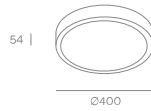

TC-0106 / DE-0288

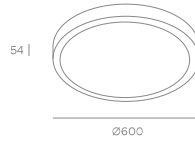

Code	Size	Color	Power	Kelvin	Rated flux	Units
TC-0105-BLA S	D400m	○ White	LED 18.3W	4000K	2550 lm	10
TC-0106-BLA S	D600m	○ White	LED 42W	4000K	4500 lm	5



Code	Size	Color	Power	Kelvin	Rated flux	Units
DE-0287-BLA N	D400m	○ White	25W	2700K - 3200K - 4000K	3240 lm*	10
DE-0287-NEG N	D400m	● Black	25W	2700K - 3200K - 4000K	3240 lm*	10
DE-0288-BLA N	D600m	○ White	41W	2700K - 3200K - 4000K	5700 lm*	5
DE-0288-NEG N	D600m	● Black	41W	2700K - 3200K - 4000K	5700 lm*	5

* Value based on 3200K.



Stac collection

Pendant lamp
P. 096



Surface mounted

Indoor Decorative

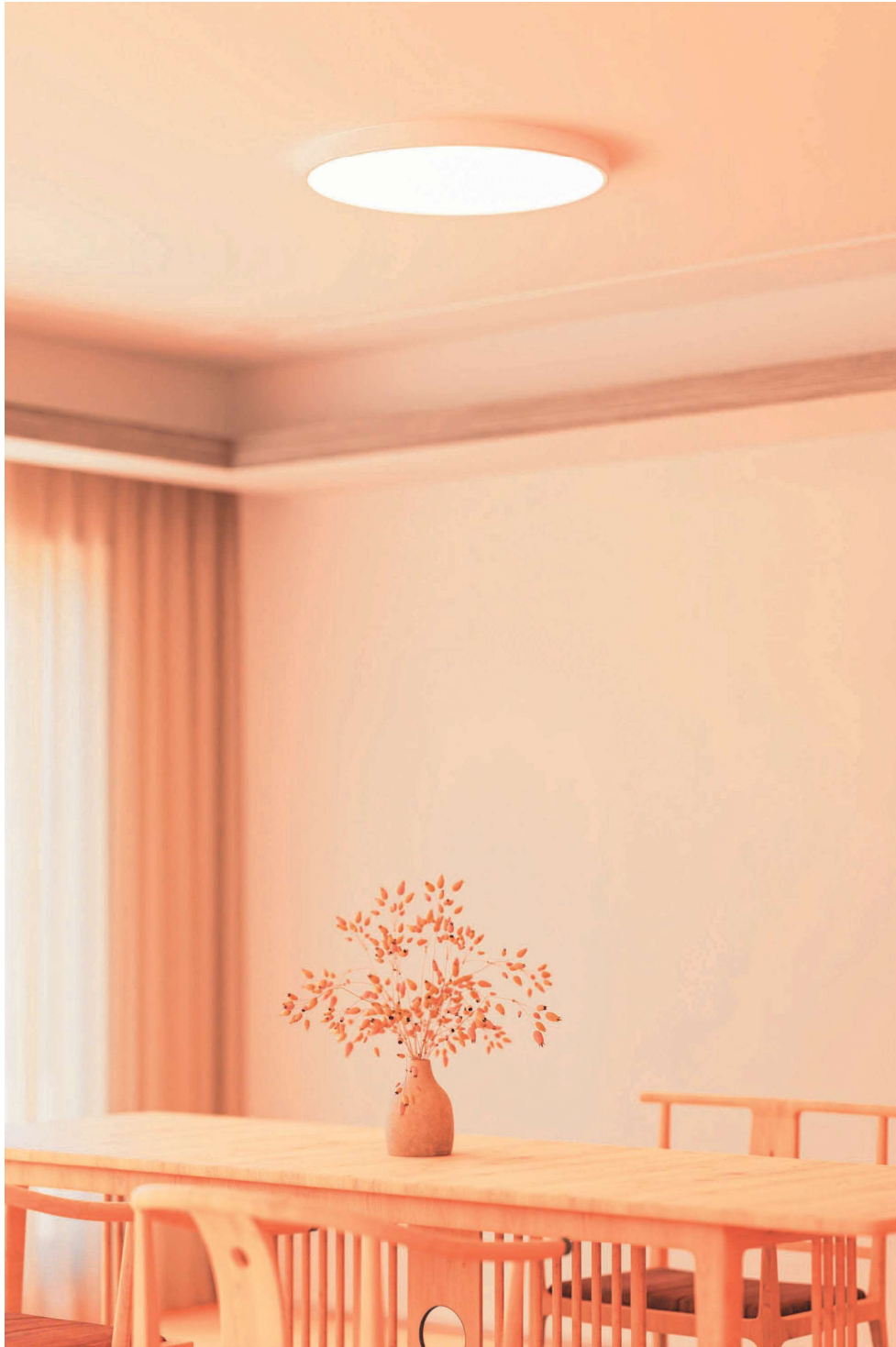

Surface mounted

Forlight

Farrow

STRUCT MAT
Steel

DIFF MAT
Glass

CLASS I
100-240V / 50-60Hz

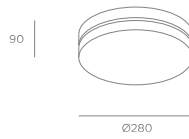

Code	Color	Power	Units
DE-0199-BLA	○ White	2x Max. 15W (LED)	4



Bulb not included

Surface mounted

Indoor Decorative



Spot series

Forlight

Kaplan NEW

STRUCT MAT
Aluminium + ABS

CLASS II
100-240V / 50-60Hz

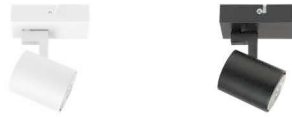

DE-0291

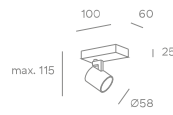

DE-0292

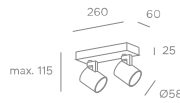

DE-0293

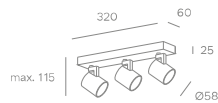

Code	Color	Power	Units
DE-0291-BLA	○ White	Max. 8W (LED)	50
DE-0291-NEG	● Black	Max. 8W (LED)	50
DE-0292-BLA	○ White	2x Max.8W (LED)	20
DE-0292-NEG	● Black	2x Max.8W (LED)	20
DE-0293-BLA	○ White	3x Max. 8W (LED)	20
DE-0293-NEG	● Black	3x Max. 8W (LED)	20



134 Bulb not included



Spot series

Forlight

Era

STRUCT MAT
Aluminium

CLASS I
100-240V / 50-60Hz

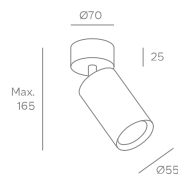

Era collection

Pendant lamp
P. 101



Reading light
P. 142



Surface
downlight
P. 048



Code	Color	Power	Units
TC-0078-BLA	○ White	Max. 8W (LED)	40
TC-0078-NEG	● Black	Max. 8W (LED)	40



136
Bulb not included

Spot series

Indoor Decorative



Spot series

Forlight

Nature

STRUCT MAT
Steel

DIFF MAT
FSC rattan

CLASS I
100-240V / 50-60Hz



DE-0219

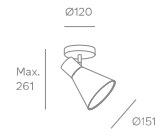

DE-0220

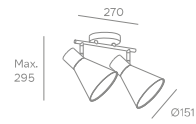

DE-0221

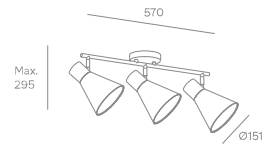

DE-0222

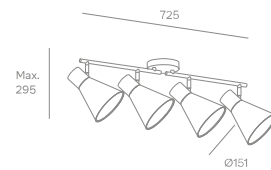

Code	Color	Fixture	Power	Units
DE-0219-NAT	● Light wood	Wall + ceiling	Max. 15W (LED)	12
DE-0220-NAT	● Light wood	Wall + ceiling	2x Max. 15W (LED)	6
DE-0221-NAT	● Light wood	Wall + ceiling	3x Max. 15W (LED)	6
DE-0222-NAT	● Light wood	Ceiling	4x Max. 15W (LED)	6



Bulb not included



90°





Spot series

Forlight

Eufo

STRUCT MAT
Steel

CLASS I
100-240V / 50-60Hz



DE-0171



DE-0172

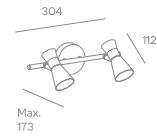

DE-0173

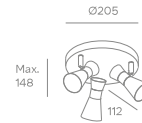

DE-0174

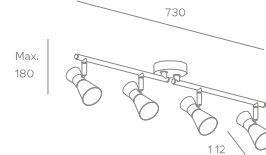

Code	Color	Installation	Power	Units
DE-0171-NEG	● Black and ● Brass	Wall + ceiling	Max. 8W (LED)	12
DE-0172-NEG	● Black and ● Brass	Wall + ceiling	2x Max. 8W (LED)	6
DE-0173-NEG	● Black and ● Brass	Ceiling	3x Max. 8W (LED)	6
DE-0174-NEG	● Black and ● Brass	Ceiling	4x Max. 8W (LED)	6



Spot series

Indoor Decorative

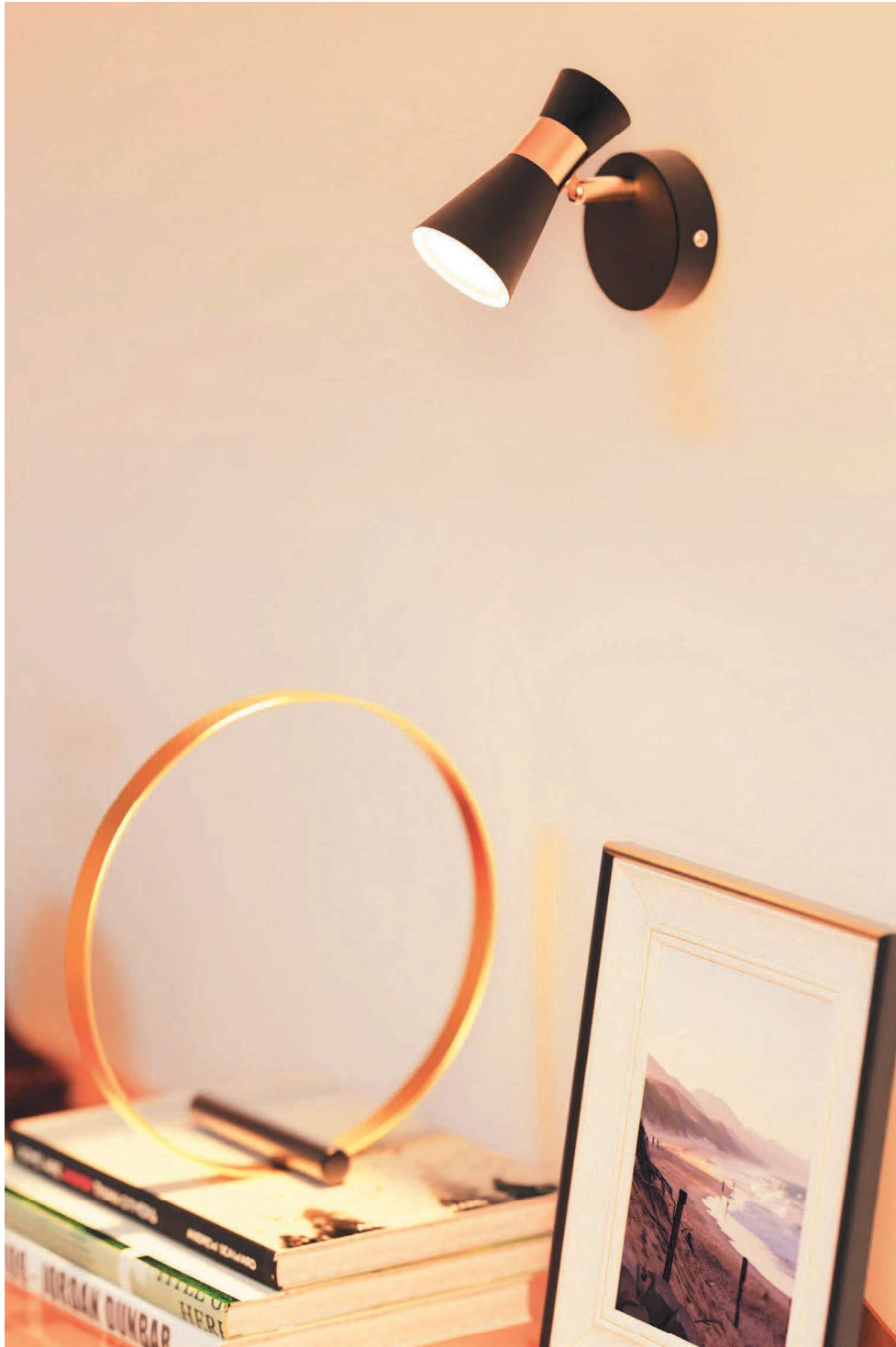

Reading light

Forlight

Era

STRUCT MAT
Aluminium

CLASS I
100-240V / 50-60Hz

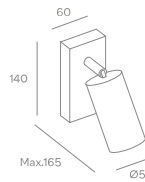

Era collection

Pendant lamp
P. 101



Spot series
P. 136



Surface
downlight
P. 048



Code	Color	Power	Units
TC-0080-BLA	○ White	Max. 8W (LED)	30
TC-0080-NEG	● Black	Max. 8W (LED)	30



142
Bulb not included

Reading light

Indoor Decorative

Colo

STRUCT MAT
Aluminium

DIFF MAT
Polycarbonate

CLASS I
220-240V / 50-60Hz

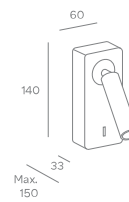

Code	Color	Power	Kelvin	Rated flux	Units
DE-0116-BLA	○ White	3,4W	3000K	184 lm	50
DE-0116-NEG	● Black	3,4W	3000K	184 lm	50
DE-0116-ORO	● Gold	3,4W	3000K	184 lm	50

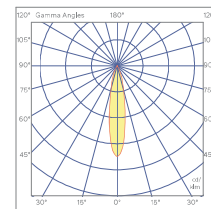

Reading light

Forlight

Crobat

STRUCT MAT
Polycarbonate + Steel

DIFF MAT
Polycarbonate

CLASS II
100-240V / 50-60Hz

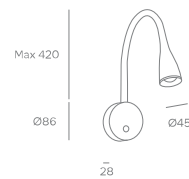

Code	Color	Power	Kelvin	Rated flux	Units
DE-0268-BLA	○ White	4,3W	3000K	450 lm	12
DE-0268-NEG	● Black	4,3W	3000K	450 lm	12

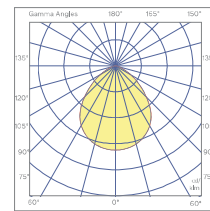

Reading light

Indoor Decorative

Mine

STRUCT MAT
Aluminium

DIFF MAT
Polycarbonate

CLASS I
220-240V / 50-60Hz

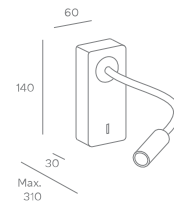

Code	Color	Power	Kelvin	Rated flux	Units
DE-0117-BLA	○ White	3,4W	3000K	184 lm	30
DE-0117-NEG	● Black	3,4W	3000K	184 lm	30
DE-0117-ORO	● Gold	3,4W	3000K	184 lm	30

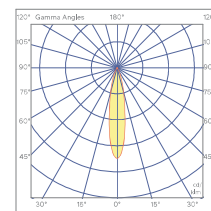

Reading light

Forlight

Bas

STRUCT MAT
Steel

CLASS I
100-240V / 50-60Hz

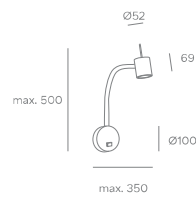

Code	Color	Power	Units
DE-0442-SAT	● Satin nickel	Max. 8W (LED)	20



146

Bulb not included

Reading light

Indoor Decorative

Lyon

STRUCT MAT
Steel

SHADE MAT
Textile

CLASS I
100-240V / 50-60Hz

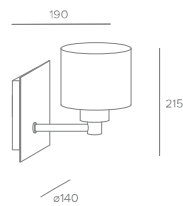

Code	Color	Power	Units
DE-0003-SAT	● Satin nickel	Max. 15W (LED)	4



Reading light

Forlight

Aura

STRUCT MAT
Aluminium

SHADE MAT
Textile

CLASS I
100-240V / 50-60Hz

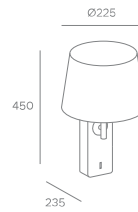
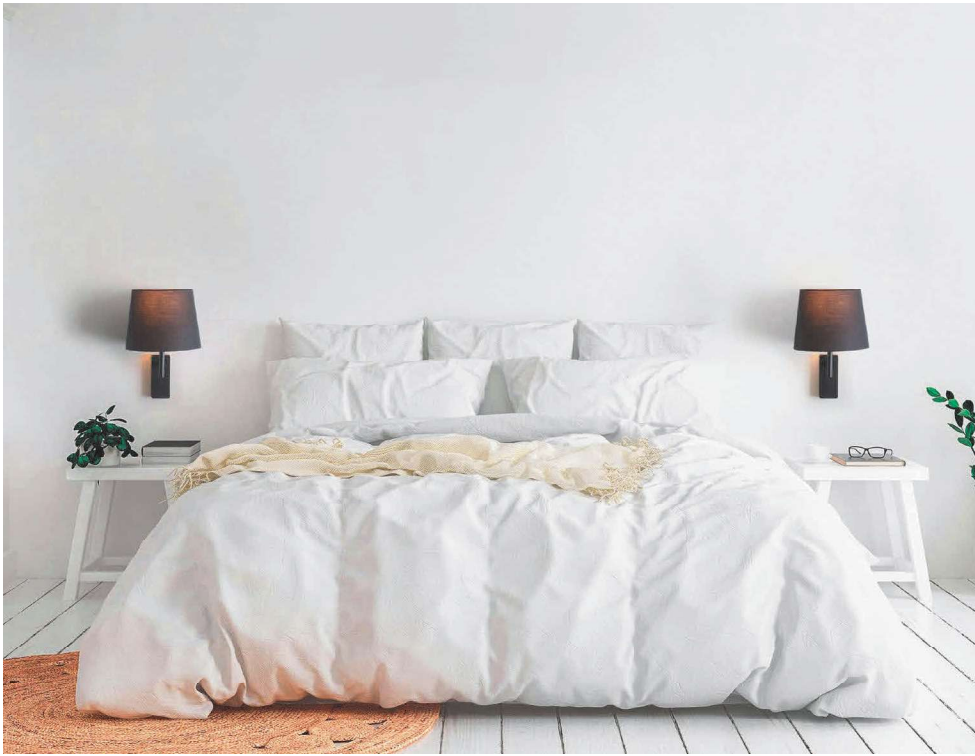

Code	Color	Power	Units
DE-0118-BLA	○ White	Max. 15W (LED)	8
DE-0118-NEG	● Black	Max. 15W (LED)	8



Bulb not included

Reading light

Indoor Decorative

Janet

STRUCT MAT
Aluminium

SHADE MAT
Textile

CLASS I
220-240V / 50-60Hz

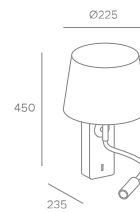

Code	Color	Power	Kelvin	Rated flux	Units
DE-0115-BLA	○ White	18,4W / 3,4W (LED) + Max.15W (E27)	3000K	184 lm	8
DE-0115-NEG	● Black	18,4W / 3,4W (LED) + Max.15W (E27)	3000K	184 lm	8

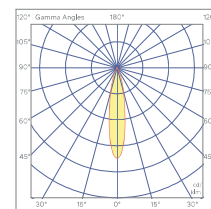

Solar
Solar
Solaire

Olaf	158
Ret	159
Cero	160
Deco	162
Lis	162
Top	163

Empotrable de suelo
Uplight recessed
Encastré sol

Tidian	N 164
Ringo	166
Incasso	167
Up	168

Luz de señalización
Wayfinding lighting
Éclairage de signalisation

Senya	N 170
Way	174

Empotrable de pared
Recessed wall fixture
Applique encastré

Zilo	N 176
Rect	178
Icon	179
Tamesis	180
Stair	181

Proyector
Spotlight
Projecteur

Vista	N 182
Crest	N 184
Trim	186
Fint	188
Pious	190
Neo	192
Lis	192
Minimal	193
Jumbo	194
Hit	195
Ousia	196
Pixa	198
Tidian	198
Post	199

Proyector de pared
Wall spotlight
Projecteur mural

Vista	N 200
Pixa	202
Eleve	203
Applique pared <i>Wall lamp</i> Applique	

Moo	204
Vit	206
New flash	207
Eclipta I	208
Eclipta II	210
Wilow	212
Kapa	212
Yika	213
Slim	214
Rex	216
Olaf	218
Ret	219
Top	220
Block	220
Samper	221
Zenitha	221
One	222
Auro	N 224
Creu	226
Kairo	N 228
Nod	232
Loyd	232
Hide	233
Orion	N 234
Ara	238
Fond	N 240
Cone	242
Kala	243
Avenue	244
Alan	245
Foix	246
Prisma	247
Area	248
Cube	250
Kubo	251
Osaka	252
Mayor	253
Thomas	254
Siluet	254
Quanta	255
Veta	256
Astra	257

Baliza
Bollard
Balise

Eclipta I	258
Eclipta II	260
One	262
Hide	264
Yika	265
Arrow	266
Top	267
Astra	268
Veta	270
Pixa	272
Cone	273
Indoo	274
Mandela	N 275
Kala	276
Koral	276
Siljan	277
Alfil	277

Luminaria de superficie
Surface mounted
Luminaire de surface

Orion	N 278
Crest	N 280
Ford	282
Scal	283



Outdoor

Exterior | Extérieur













Solar

Forlight

Olaf

STRUCT MAT
Recycled plastic

DIFF MAT
Polycarbonate

CLASS III

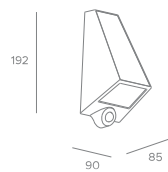

Code	Color	Power	Kelvin	Rated flux	Units
PX-0693-NEG	● Black	6,5W	3000K	800 lm	32



Solar

Outdoor

Ret

STRUCT MAT
Recycled plastic

DIFF MAT
Polycarbonate

CLASS III

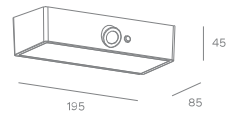

Code	Color	Power	Kelvin	Rated flux	Units
PX-0593-NEG	● Black	6,5W	3000K	960 lm	10



Solar

Forlight

Cero

STRUCT MAT
Polycarbonate and ABS

DIFF MAT
Polycarbonate

CLASS III

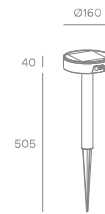

Triple use



Code	Color	Power	Kelvin	Rated flux	Units
PX-0646-NEG	● Black	4,3W	3000K - 4000K - 6000K	500 lm*	20

* Value based on 4000K.



Solar

Outdoor



Solar

Forlight

Deco

STRUCT MAT
Steel

DIFF MAT
Polycarbonate

CLASS III
5V / 1A



Handle to adjust brightness levels.

Code	Color	Power	Kelvin	Rated flux	Units
PX-0263-NEG S	● Black	2,8W	3000K	280 lm	8



Lis

STRUCT MAT
PC and Stainless steel

DIFF MAT
Polycarbonate

CLASS III

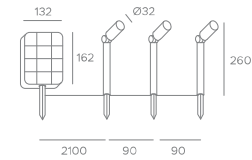

Code	Color	Power	Kelvin	Rated flux	Units
PX-0451-NEG S	● Black	3W	3000K	300 lm	6



Solar

Outdoor

Top

STRUCT MAT
Aluminium

DIFF MAT
Tempered glass

CLASS III

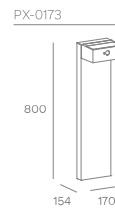
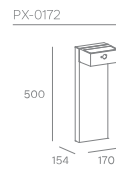
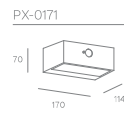

Code	Color	Power	Kelvin	Rated flux	Units
PX-0171-ANT	● Urban grey	3W	3000K	400 lm	16
PX-0172-ANT	● Urban grey	3W	3000K	400 lm	4
PX-0173-ANT	● Urban grey	3W	3000K	400 lm	4



Uplight recessed

Forlight

Tidian NEW

STRUCT MAT
Technopolymer

DIFF MAT
Glass

CLASS I
100-240V / 50-60Hz

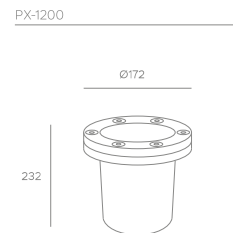
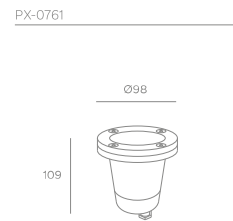

Code	Color	Power	Kelvin	Rated flux	Units
PX-0761-NEG N	● Black	3.8W	3000K	395 lm	12
PX-1200-NEG	● Black	Max. 15W (LED)	-	-	6

Bulb not included

Uplight recessed

Outdoor



Uplight recessed

Forlight

Ringo

STRUCT MAT
Stainless steel AISI 304

DIFF MAT
Glass

CLASS I
100-240V / 50-60Hz

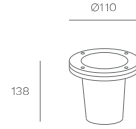

Code	Color	Power	Units
PX-1000-INO	● Stainless steel	Max. 8W (LED)	12

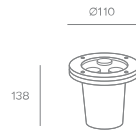

Code	Color	Power	Kelvin	Rated flux	Units
PX-0128-INO	● Stainless steel	3,5W	3000K	370 lm	12
PX-0123-INO	● Stainless steel	3,5W	4000K	420 lm	12

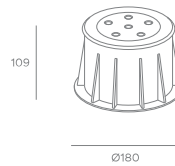

Code	Color	Power	Kelvin	Rated flux	Units
PX-0355-INO	● Stainless steel	10,1W	3000K	1280 lm	12



Uplight recessed

Outdoor

Incasso

STRUCT MAT
Stainless steel AISI 304

DIFF MAT
Glass

CLASS I
100-240VAC / 50-60Hz

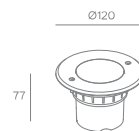

Code	Color	Power	Kelvin	Rated flux	Units
PX-0520-INO	● Stainless steel	6,2W	3000K	500 lm	8



Uplight recessed

Forlight

Up

STRUCT MAT
Aluminium

DIFF MAT
Polycarbonate

CLASS I
220-240V / 50-60Hz



PX-0557

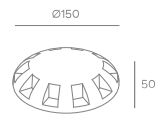

Code	Color	Power	Kelvin	Rated flux	Units
PX-0557-ANT S	● Urban grey	10,6W	3000K	870 lm	16



Uplight recessed

Outdoor



Senya NEW

STRUCT MAT
Aluminium

DIFF MAT
Polycarbonate

CLASS II
220-240V / 50-60Hz



PX-0370

PX-0371



Suitable for foot traffic.

Code	Color	Power	Kelvin	Rated flux	Units
PX-0370-BLA N	○ White	1,2W	3000K	92 lm	40
PX-0370-NEG N	● Black	1,2W	3000K	92 lm	40
PX-0370-ALU	● Aluminium	1,2W	3000K	92 lm	40
PX-0371-BLA N	○ White	2,2W	3000K	200 lm	20
PX-0371-NEG N	● Black	2,2W	3000K	200 lm	20
PX-0371-ALU	● Aluminium	2,2W	3000K	200 lm	20

Senya collection

Wayfinding
lighting
P. 172



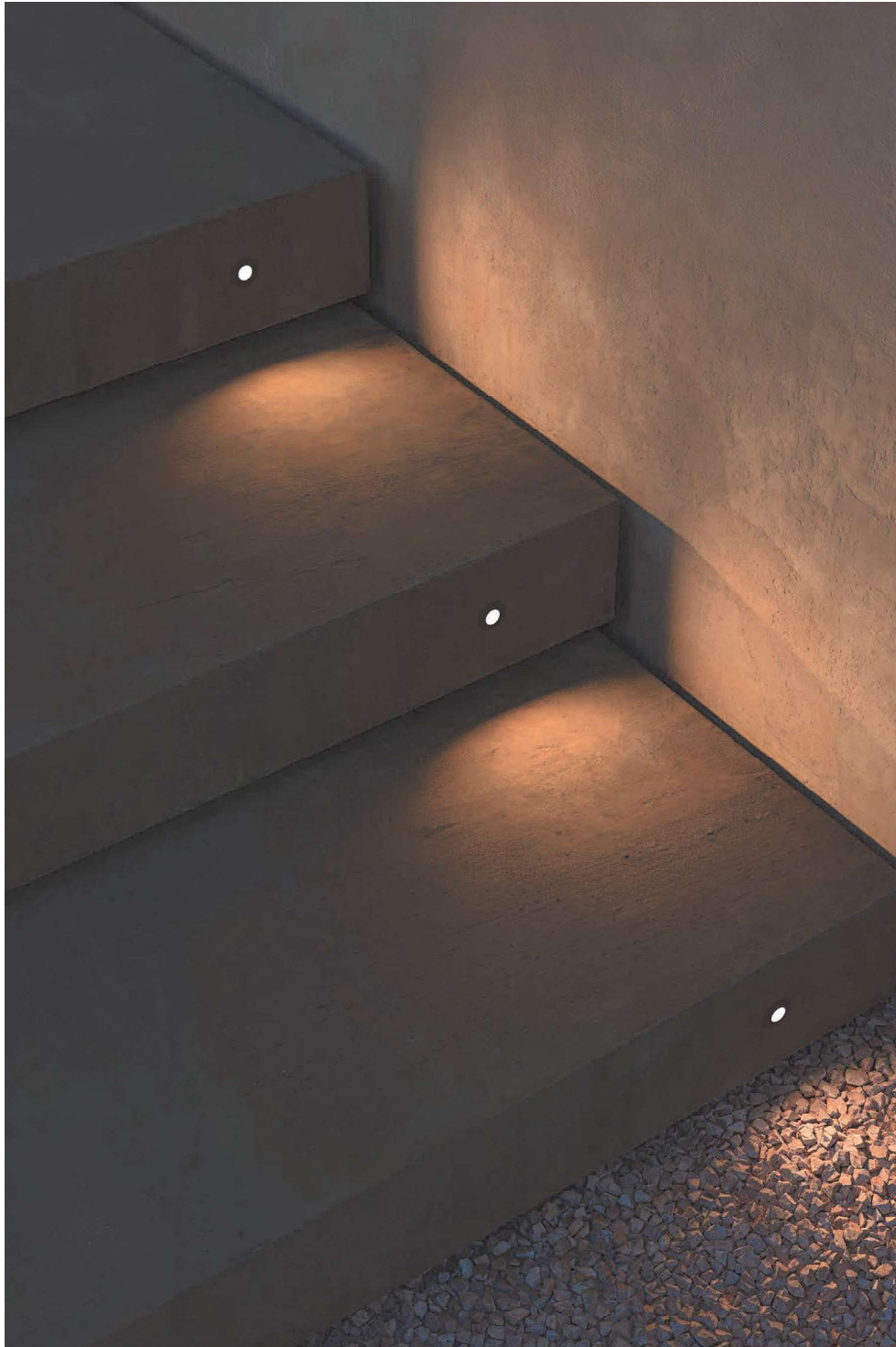

Wayfinding lighting

Forlight

Senya NEW

STRUCT MAT
Aluminium

DIFF MAT
Polycarbonate

CLASS II
220-240V / 50-60Hz



PX-0771

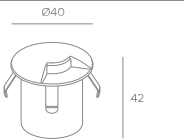

PX-0772

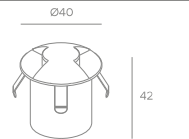

PX-0773

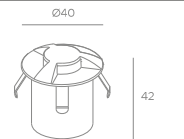

Suitable for foot traffic.

Code	Color	Power	Kelvin	Rated flux	Units
PX-0771-ALU	● Aluminium	1,2W	3000K	92 lm	40
PX-0772-ALU	● Aluminium	1,2W	3000K	92 lm	40
PX-0773-ALU	● Aluminium	1,2W	3000K	92 lm	40



Senya collection

Passageway
lighting
P. 060





Wayfinding lighting

Forlight

Way

STRUCT MAT
Aluminium



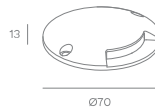

DIFF MAT
Polycarbonate

PX-0423: CLASS II
220-240V / 50-60Hz

PX-0349: CLASS III
12V DC



Suitable for foot traffic.

Code	Color	Power	Kelvin	Rated flux	Units
PX-0423-GRI 	 Grey	0,3W	3000K	27 lm	30
PX-0349-GRI 	 Grey	0,4W	3000K	27 lm	30



PX-0423 PX-0349



Recessed wall fixture

Forlight

Zilo NEW

STRUCT MAT
Aluminium

DIFF MAT
Glass

CLASS I
100-277V / 50-60Hz

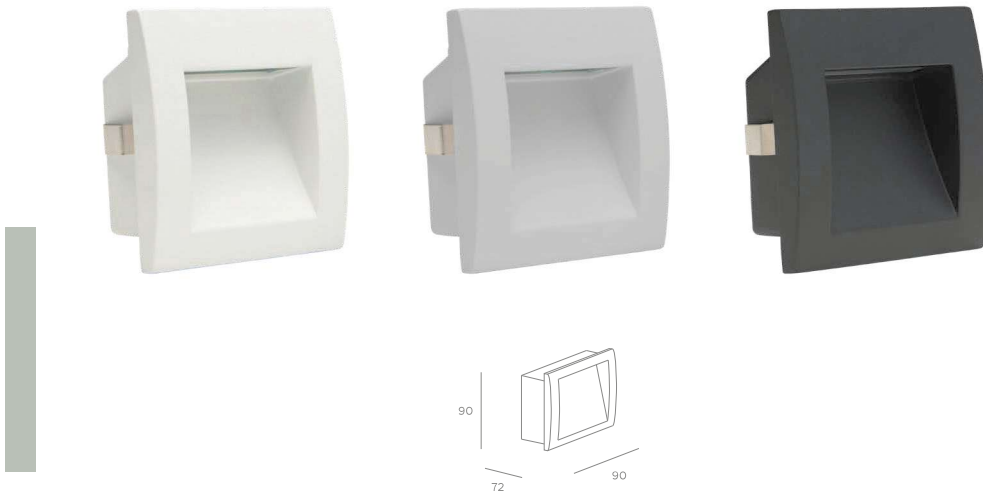

Code	Color	Power	Kelvin	Rated flux	Units
PX-0756-BLA	○ White	3,6W	2700K - 3200K - 4000K	465 lm*	50
PX-0756-GRI	● Grey	3,6W	2700K - 3200K - 4000K	465 lm*	50
PX-0756-NEG	● Black	3,6W	2700K - 3200K - 4000K	465 lm*	50

*Value based on 3200K



Recessed wall fixture

Outdoor

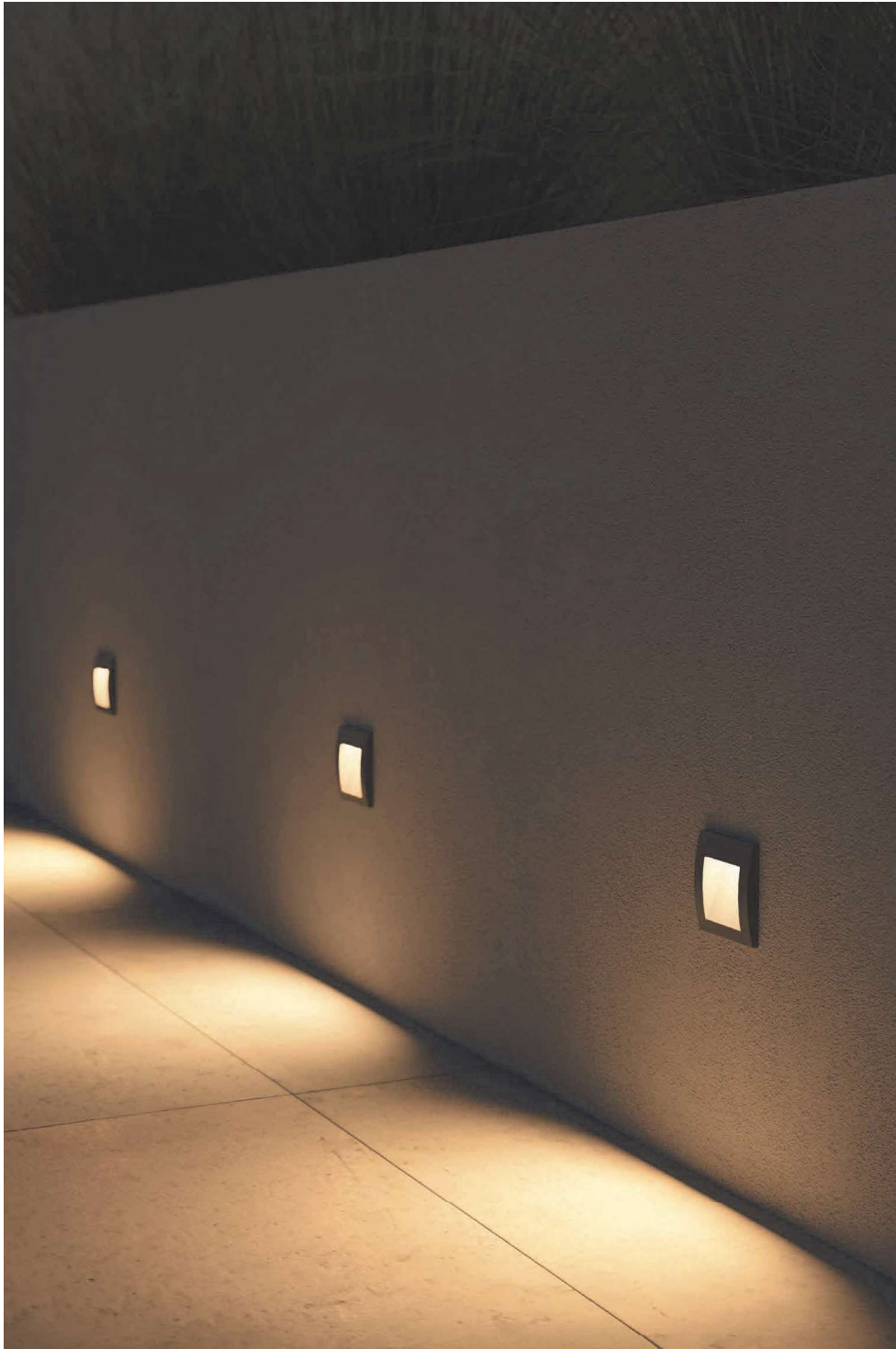

Recessed wall fixture

Forlight

Rect

STRUCT MAT
Stainless steel AISI 304

DIFF MAT
Polycarbonate

PX-0549: CLASS I
220-240V / 50-60Hz

PX-0541 / PX-0540: CLASS II
220-240V / 50-60Hz



Code	Color	Power	Kelvin	Rated flux	Units
PX-0549-ALU	● Grey	2,3W	3000K - 4000K - 6500K	323 lm*	100

* Value based on 4000K.



PX-0541



PX-0540

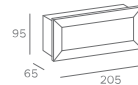

Code	Color	Power	Kelvin	Rated flux	Units
PX-0541-ALU	● Grey	3,3W	3000K	345 lm	48
PX-0540-ALU	● Grey	3,3W	3000K	345 lm	50



Recessed wall fixture

Outdoor

Icon

STRUCT MAT
Aluminium/ Polycarbonate and ABS

DIFF MAT
Polycarbonate

CLASS I
220-240V / 50-60Hz



PX-0357

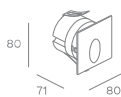

PX-0358



Code	Color	Power	Kelvin	Rated flux	Units
PX-0357-NEG	● Black	3,3W	3000K	228 lm	36
PX-0358-NEG	● Black	3,3W	3000K	228 lm	36



Recessed wall fixture

Forlight

Tamesis

STRUCT MAT
Aluminium

DIFF MAT
Glass

CLASS I
100-240V / 50-60Hz

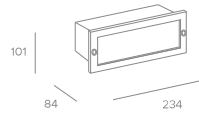

3 covers included



Code	Color	Power	Units
PX-0047-GRI	○ White / ● Grey / ● Black	Max.15W (LED)	18



Bulb not included



STRUCT MAT
Stainless steel AISI 304

DIFF MAT
Glass

CLASS I
100-240V / 50-60Hz

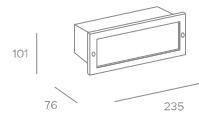

Cover included



Code	Color	Power	Units
PX-0465-INO	○ Stainless steel	Max. 15W (LED)	18



Bulb not included



Recessed wall fixture

Outdoor

Stair

STRUCT MAT
Stainless steel AISI 304

DIFF MAT
Acrylic

CLASS II
100-240V / 50-60Hz

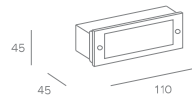
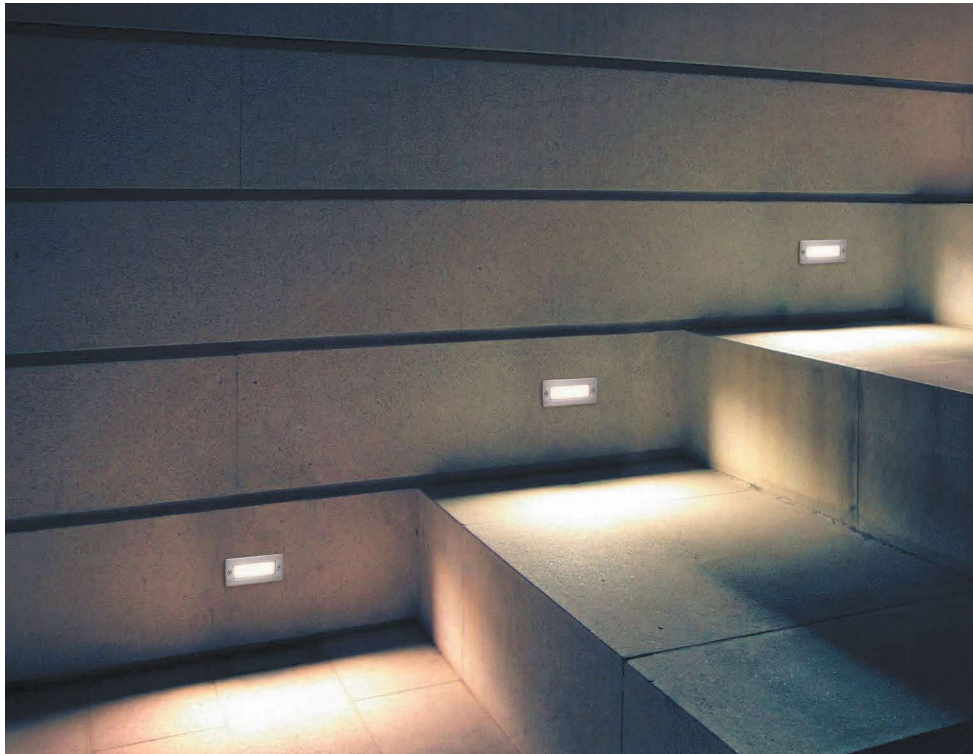

Code	Color	Power	Kelvin	Rated flux	Units
PX-0122-INO S	● Stainless steel	1,3W	3000K	150 lm	40



Spotlight

Forlight

Vista NEW

STRUCT MAT
Stainless steel AISI304

DIFF MAT
Glass

CLASS I
100-240VAC / 50-60Hz

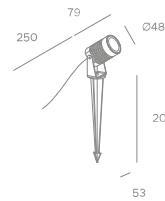

Vista collection

Wall spotlight
P. 200



Code	Color	Power	Kelvin	Rated flux	Units
PX-0768-NEG	● Black	4,9W	3000k	525 lm	20



Spotlight

Outdoor



Spotlight

Forlight

Crest NEW

STRUCT MAT
Aluminium

DIFF MAT
Glass / Polycarbonate

CLASS I
100-240V / 50-60Hz

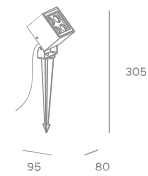

Crest collection

Code	Color	Power	Kelvin	Rated flux	Units
PX-0766-NEG	● Black	8,2W	3000K	800 lm	20

Surface mounted
P. 280





Spotlight

Forlight

Trim

STRUCT MAT
Aluminium

DIFF MAT
Glass

CLASS I
220-240VAC / 50-60Hz



PX-0647

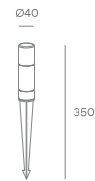

PX-0648

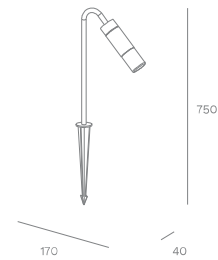

Code	Color	Power	Kelvin	Rated flux	Units
PX-0647-NEG	● Black	3,5W	3000K	280 lm	50
PX-0647-MAR	● Brown	3,5W	3000K	280 lm	50
PX-0648-NEG	● Black	3,5W	3000K	280 lm	20
PX-0648-MAR	● Brown	3,5W	3000K	280 lm	20



Spotlight

Outdoor



Spotlight

Forlight

Fint

STRUCT MAT
Aluminium

DIFF MAT
Polycarbonate

CLASS I
220-240V / 50-60Hz



PX-0671

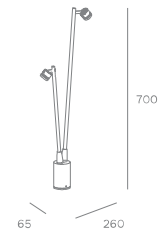

PX-0672

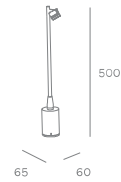

Code	Color	Power	Kelvin	Rated flux	Units
PX-0671-NEG	● Black	6,4W	3000K	635 lm	10
PX-0671-MAR	● Brown	6,4W	3000K	635 lm	10
PX-0672-NEG	● Black	3,5W	3000K	285 lm	20
PX-0672-MAR	● Brown	3,5W	3000K	285 lm	20



Spotlight

Outdoor



Spotlight

Forlight

Pious

STRUCT MAT
Aluminium

DIFF MAT
Glass

CLASS I
220-240VAC / 50-60Hz

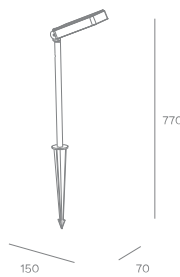

Code	Color	Power	Kelvin	Rated flux	Units
PX-0670-NEG	● Black	3,5W	3000K	290 lm	20



Spotlight

Outdoor



Spotlight

Forlight

Neo

STRUCT MAT
Polycarbonate and ABS

DIFF MAT
Polycarbonate

CLASS I
100-240V / 50-60Hz

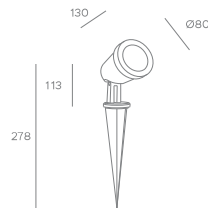

Code	Color	Power	Kelvin	Rated flux	Units
PX-0374-NEG S	● Black	6W	3000K	500 lm	16



Lis

STRUCT MAT
PC and Stainless steel

DIFF MAT
Polycarbonate

CLASS III

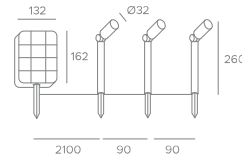

Code	Color	Power	Kelvin	Rated flux	Units
PX-0451-NEG S	● Black	3W	3000K	300 lm	6



Spotlight

Outdoor

Minimal

STRUCT MAT
Aluminium and Steel

DIFF MAT
Glass

CLASS I
100-240V / 50-60Hz



Code	Color	Power	Kelvin	Rated flux	Units
PX-0144-NEG	● Black	8W	3000K	715 lm	12
PX-0361-NEG S	● Black	8,6W	4000K	780 lm	12



Spotlight

Forlight

Jumbo

STRUCT MAT
Polycarbonate and ABS

DIFF MAT
Polycarbonate

CLASS II
100-240V / 50-60Hz

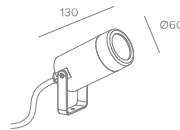

Code	Color	Power	Units
PX-0135-NEG	● Black	Max. 8W (LED)	20



Bulb not included

Spotlight

Outdoor

Hit

STRUCT MAT
Aluminium

DIFF MAT
Glass

CLASS I
100-240V / 50-60Hz



PX-0360

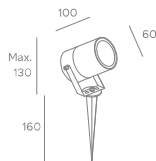

PX-0633

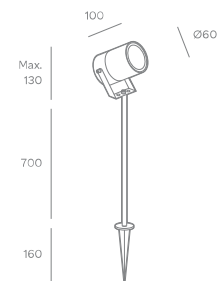

Code	Color	Power	Units
PX-0633-NEG	● Black	Max. 8W (LED)	30
PX-0360-NEG	● Black	Max. 8W (LED)	20



Bulb not included



PX-0633

PX-0360

Spotlight

Forlight

Ousia

STRUCT MAT
Aluminium

DIFF MAT
Glass

CLASS I
100-240V / 50-60Hz



PX-0634

PX-0636

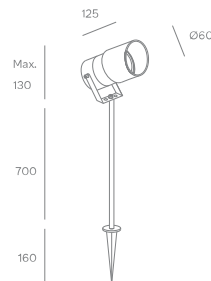
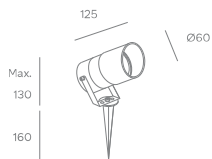

Code	Color	Power	Units
PX-0634-NEG	● Black	Max. 8W (LED)	36
PX-0636-NEG	● Black	Max. 8W (LED)	30



196
Bulb not included

Spotlight

Outdoor

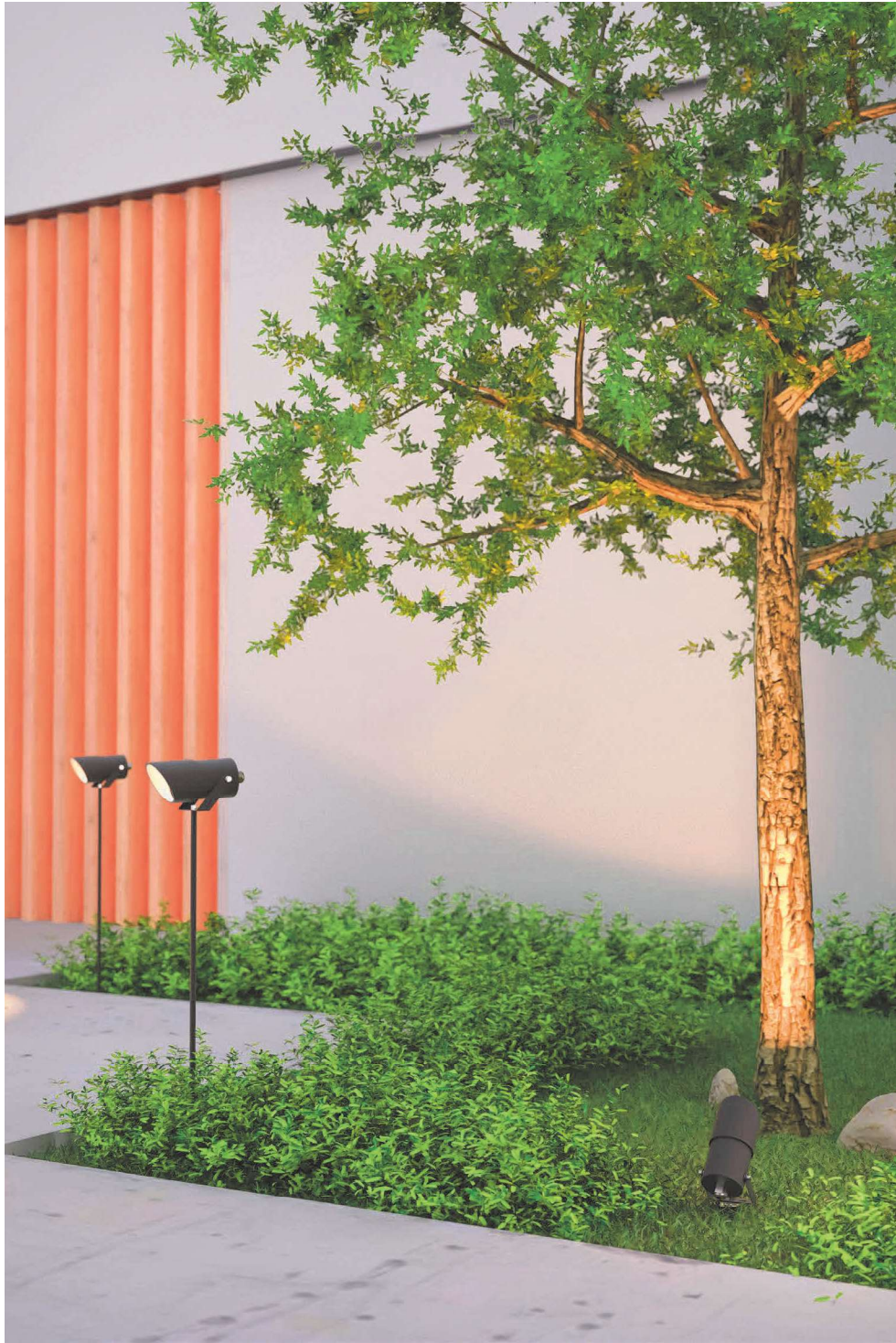

Spotlight

Forlight

Pixa

STRUCT MAT
Stainless steel AISI202

DIFF MAT
Glass

CLASS I
100-240V / 50-60Hz

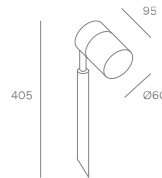

Pixa collection

Wall spotlight
P. 202



Bollard
P. 272



Code	Color	Power	Units
PX-0533-NEG S	● Black	Max. 8W (LED)	16



Bulb not included



Tidian

STRUCT MAT
Technopolymer

DIFF MAT
Glass

CLASS II
100-240V / 50-60Hz

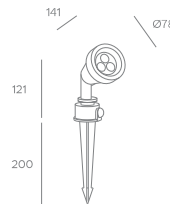

Code	Color	Power	Units
PX-0214-NEG	● Black	Max. 8W (LED)	20



Bulb not included



Spotlight

Outdoor

Post

STRUCT MAT
Aluminium

DIFF MAT
Glass

CLASS I
100-240V / 50-60Hz

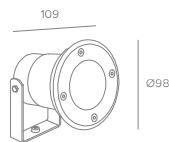

Code	Color	Power	Units
PX-1400-BLA	○ White	Max. 8W (LED)	20
PX-1400-GRI	● Grey	Max. 8W (LED)	20
PX-1400-NEG	● Black	Max. 8W (LED)	20



Bulb not included



Wall spotlight

Forlight

Vista NEW

STRUCT MAT
Stainless steel AISI304

DIFF MAT
Glass

CLASS I
100-240VAC / 50-60Hz

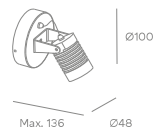

Vista collection

Spotlight
P. 182



Code	Color	Power	Kelvin	Rated flux	Units
PX-0767-NEG	● Black	4,9W	3000K	525 lm	20



Wall spotlight

Outdoor

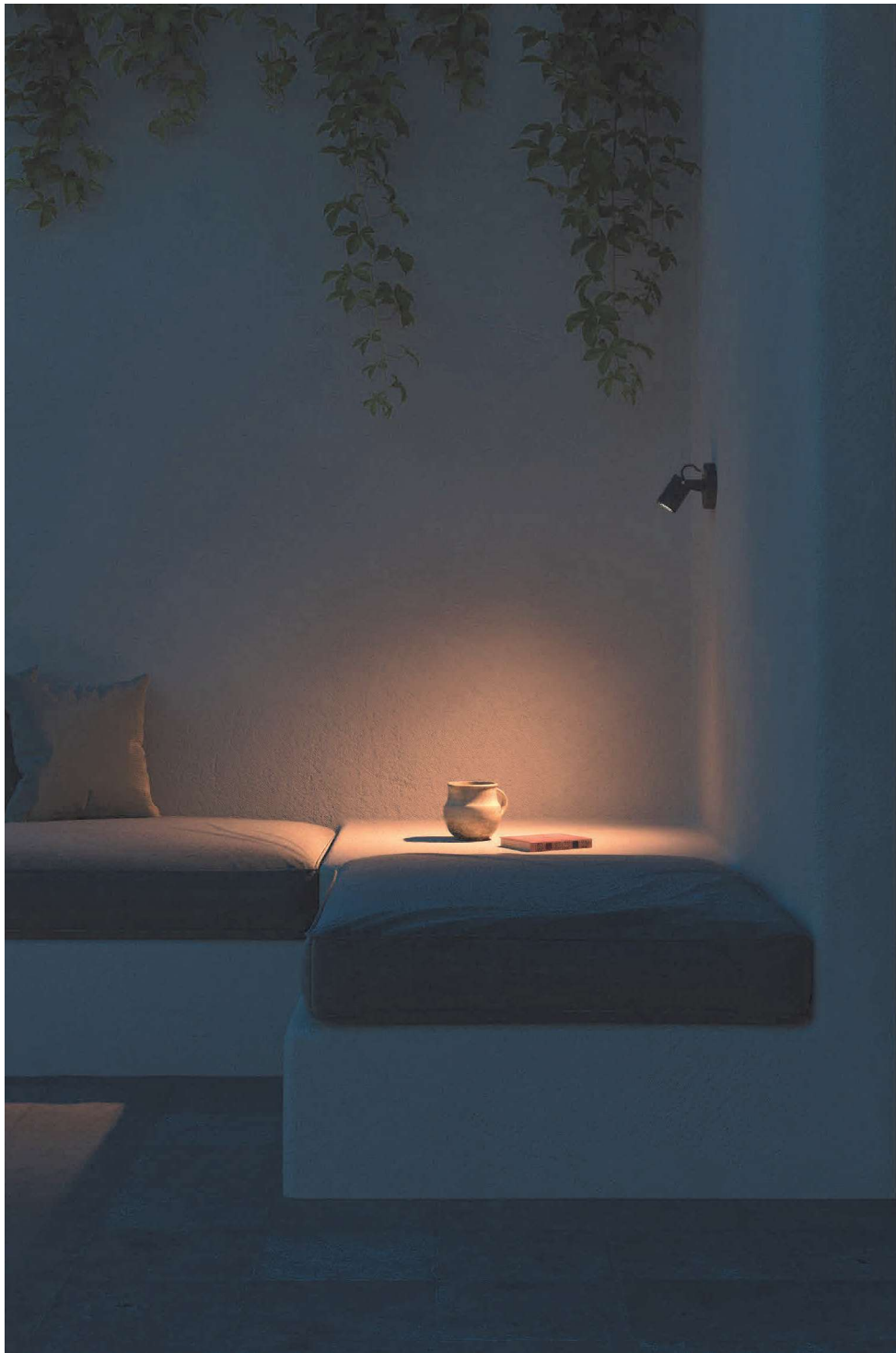

Wall spotlight

Forlight

Pixa

STRUCT MAT
Stainless steel AISI 202

DIFF MAT
Glass

CLASS I
100-240V / 50-60Hz



PX-0556



PX-0523



Pixa collection

Code	Color	Power	Units
PX-0556-NEG S	● Black	Max. 8W (LED)	12
PX-0523-NEG S	● Black	2x Max. 8W (LED)	12



Bulb not included



Spotlight
P. 198



Bollard
P. 272



Wall spotlight

Outdoor

Eleve

STRUCT MAT
Aluminium

DIFF MAT
Glass

CLASS I
100-240V / 50-60Hz

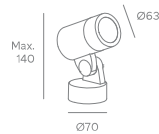

3 in 1 product, suitable for wall, ceiling and floor installation.

Code	Color	Power	Units
PX-0366-NEG	● Black	Max. 8W (LED)	20



Bulb not included



Wall lamp

Forlight

Moo

STRUCT MAT
ABS

DIFF MAT
Plastic

CLASS II
220-240V / 50-60Hz



PX-0701

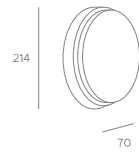

PX-0702

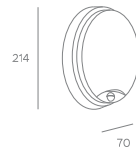

PX-0699

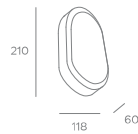

PX-0700

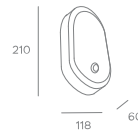

Code	Color	Power	Kelvin	Rated flux	Units
PX-0701-BLA	○ White	18W	2700 - 3200 - 4000K	2500 lm*	24
PX-0702-BLA	○ White	18W	2700 - 3200 - 4000K	2500 lm*	24
PX-0699-BLA	○ White	18W	2700 - 3200 - 4000K	2500 lm*	24
PX-0700-BLA	○ White	18W	2700 - 3200 - 4000K	2500 lm*	24

* Value based on 3200K.

PX-0702 / PX-0700











Wall lamp

Outdoor



Wall lamp

Forlight

Vit

STRUCT MAT
Polycarbonate

DIFF MAT
Polycarbonate

CLASS II
100-240V / 50-60Hz



Two options of frames included.



Code	Color	Power	Units
PX-0197-NEG S	○ White / ● Black	Max. 15W (LED)	16



206
Bulb not included

Wall lamp

Outdoor

New flash

STRUCT MAT
Polycarbonate

DIFF MAT
Polycarbonate

CLASS II
100-240V / 50-60Hz

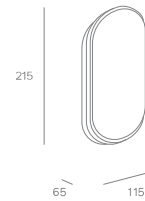

Code	Color	Power	Kelvin	Rated flux	Units
PX-0507-BLA S	○ White	15,8W	3000K	1500 lm	6
PX-0507-NEG S	● Black	15,8W	3000K	1500 lm	6



Wall lamp

Forlight

Eclipta I

STRUCT MAT
Aluminium

DIFF MAT
Polycarbonate and glass

CLASS I
220-240V / 50-60Hz

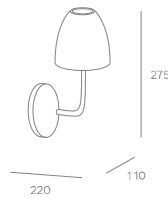

Eclipta I collection

Bollard
P. 258



Code	Color	Power	Kelvin	Rated flux	Units
PX-0691-NEG	● Black	10W	3000K	1190 lm	6
PX-0691-MAR	● Brown	10W	3000K	1190 lm	6
PX-0691-VRD	● Green	10W	3000K	1190 lm	6



Wall lamp

Outdoor



Wall lamp

Forlight

Eclipta II

STRUCT MAT
Aluminium

DIFF MAT
Polycarbonate

CLASS II
220-240V / 50-60Hz

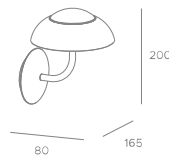

Eclipta II collection

Bollard
P. 260



Code	Color	Power	Kelvin	Rated flux	Units
PX-0695-NEG	● Black	9W	3000K	1000 lm	12
PX-0695-MAR	● Brown	9W	3000K	1000 lm	12
PX-0695-VRD	● Green	9W	3000K	1000 lm	12



Wall lamp

Outdoor

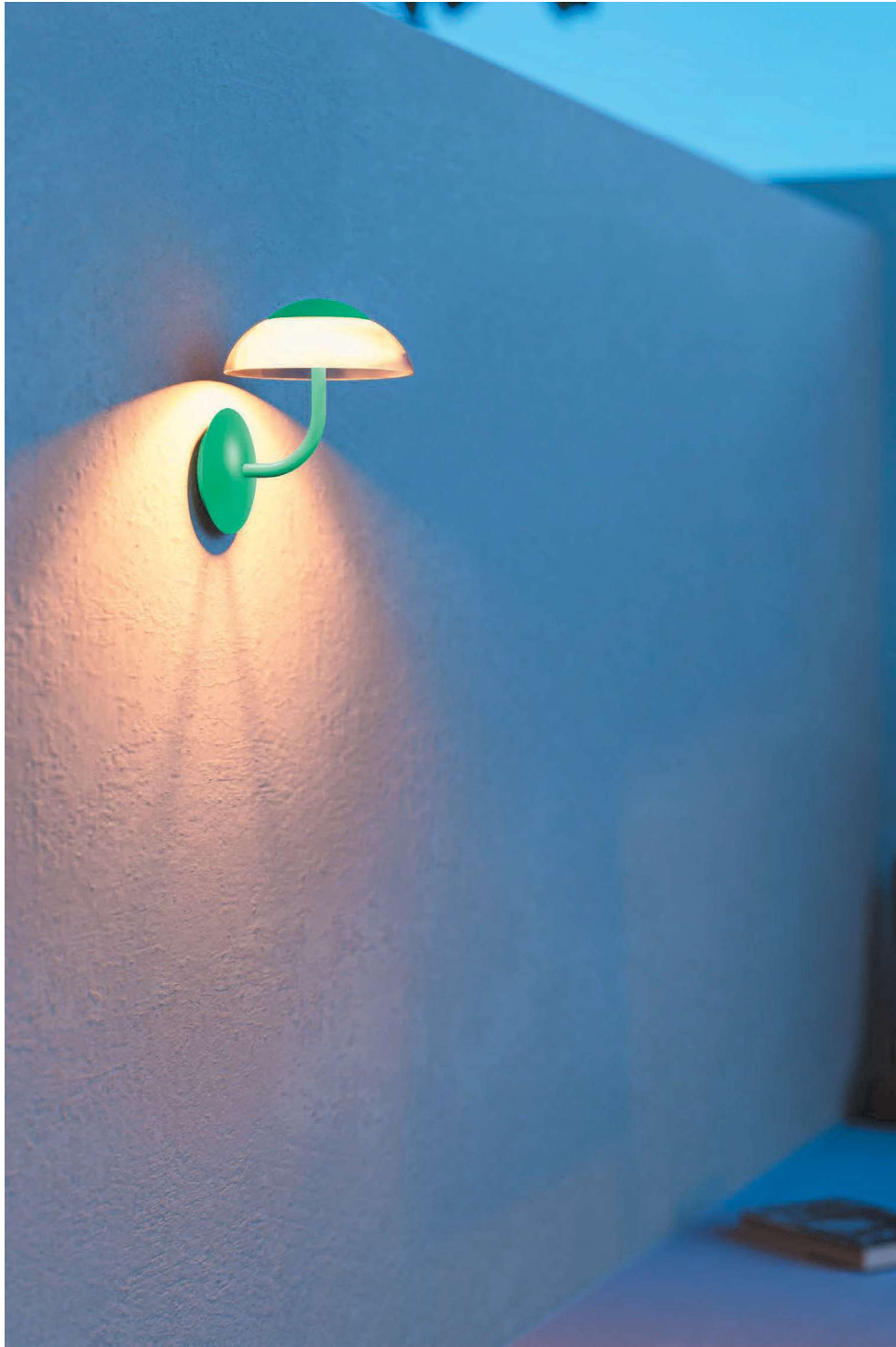

Wall lamp

Forlight

Wilow

STRUCT MAT
Aluminium

DIFF MAT
Glass

CLASS I
100-240V / 50-60Hz

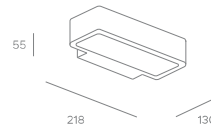

Code	Color	Power	Kelvin	Rated flux	Units
PX-0397-NEG S	● Black	8,8W	3000K	600 lm	20



Kapa

STRUCT MAT
Aluminium

DIFF MAT
Polycarbonate

CLASS I
220-240V / 50-60Hz

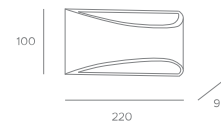

Code	Color	Power	Kelvin	Rated flux	Units
PX-0468-BLA	○ White	10W	3000K	945 lm	12
PX-0468-ANT	● Urban grey	10W	3000K	945 lm	12
PX-0525-BLA	○ White	10W	4000K	945 lm	12
PX-0525-ANT	● Urban grey	10W	4000K	945 lm	12



Easily replaceable LED module.



Wall lamp

Outdoor

Yika









STRUCT MAT
Polycarbonate and ABS

DIFF MAT
Polycarbonate

CLASS II
100-240V / 50-60Hz



Code	Color	Power	Kelvin	Rated flux	Units
PX-0486-NEG	● Black	7,9W	3000K	690 lm	12

							
---	---	---	---	---	---	---	---

Yika collection

Bollard
P. 265



Wall lamp

Forlight

Slim

STRUCT MAT
Aluminium

DIFF MAT
Glass

CLASS I
PX-0433: 100-240V / 50-60Hz PX-0563: 220-240V / 50-60Hz



PX-0433

PX-0563

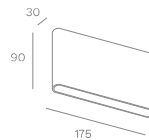
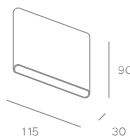

Code	Color	Power	Kelvin	Rated flux	Units
PX-0433-BLA	○ White	5W	3000K	320 lm	20
PX-0433-ANT	● Urban grey	5W	3000K	320 lm	20
PX-0563-NEG	● Black	10,3W	3000K	1200 lm	20



Wall lamp

Outdoor



Wall lamp

Forlight

Rex

STRUCT MAT
Aluminium

DIFF MAT
Glass

CLASS I
100-240V / 50-60Hz

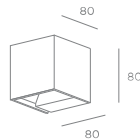
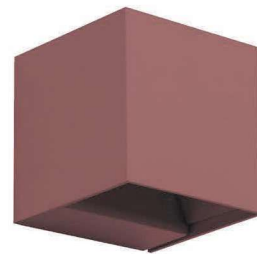

Code	Color	Power	Kelvin	Rated flux	Units
PX-0432-BLA	○ White	6,6W	3000K	680 lm	27
PX-0432-ANT	● Urban grey	6,6W	3000K	680 lm	27
PX-0432-MAR	● Brown	6,6W	3000K	680 lm	27
PX-0526-BLA	○ White	6,6W	4000K	780 lm	27
PX-0526-ANT	● Urban grey	6,6W	4000K	780 lm	27



Wall lamp

Outdoor



Wall lamp

Forlight

Olaf

STRUCT MAT
Recycled plastic

DIFF MAT
Polycarbonate

CLASS III

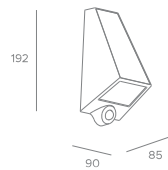

Code	Color	Power	Kelvin	Rated flux	Units
PX-0693-NEG	● Black	6,5W	3000K	800 lm	32



Wall lamp

Outdoor

Ret

STRUCT MAT
Recycled plastic

DIFF MAT
Polycarbonate

CLASS III

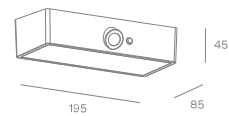
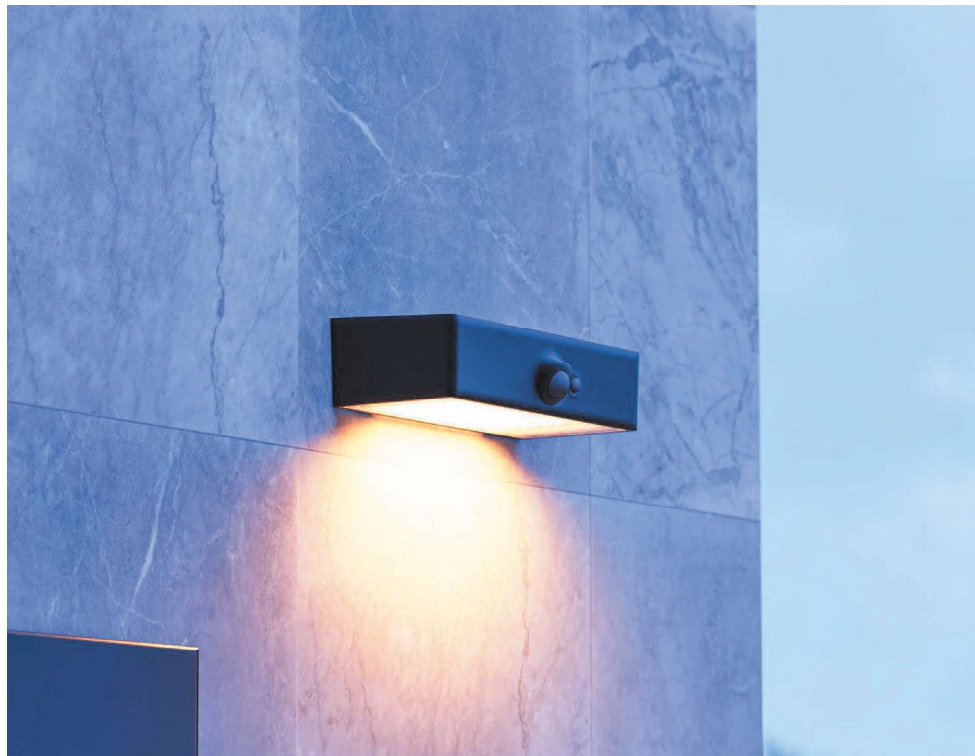

Code	Color	Power	Kelvin	Rated flux	Units
PX-0593-NEG	● Black	6,5W	3000K	960 lm	10



Wall lamp

Forlight

Top

STRUCT MAT
Aluminium

DIFF MAT
Tempered glass

CLASS III

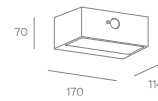

Code	Color	Power	Kelvin	Rated flux	Units
PX-0171-ANT S	● Urban grey	3W	3000K	400 lm	16

Top collection



Bollard
P. 267



Block

STRUCT MAT
Aluminium

DIFF MAT
Polycarbonate

CLASS I
220-240V / 50-60Hz

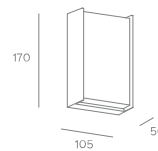

Code	Color	Power	Kelvin	Rated flux	Units
PX-0454-ANT	● Urban grey	9,7W	4000K	1125 lm	8



Wall lamp

Outdoor

Samper

STRUCT MAT
Polycarbonate and ABS

DIFF MAT
Polycarbonate

CLASS II
220-240V / 50-60Hz

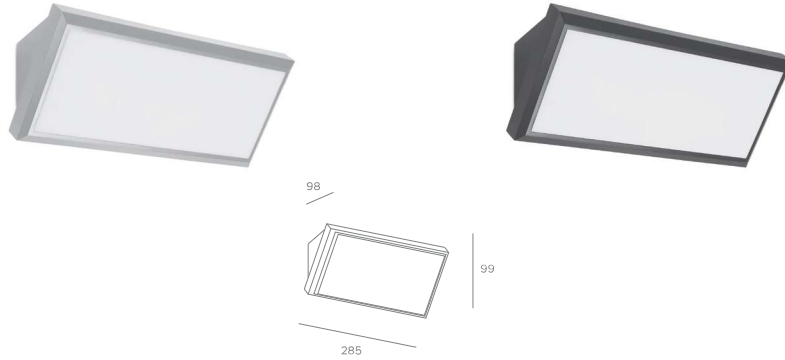

Code	Color	Power	Kelvin	Rated flux	Units
PX-0287-GRI	● Grey	12W	3000K	1100 lm	16
PX-0287-NEG	● Black	12W	3000K	1100 lm	16



Zenitha

STRUCT MAT
Aluminium

DIFF MAT
Polycarbonate

CLASS I
220-240VAC / 50-60Hz



PX-0649

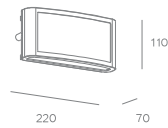

PX-0650

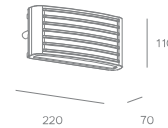

Code	Color	Power	Kelvin	Rated flux	Units
PX-0649-NEG	● Black	12W	3000K	1300 lm	18
PX-0650-NEG	● Black	12W	3000K	1300 lm	18



Wall lamp

Forlight

One

STRUCT MAT
Aluminium

DIFF MAT
Polycarbonate

CLASS I
100-240VAC / 50-60Hz

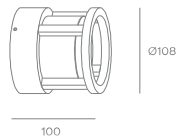

One collection

Bollard
P. 262



Code	Color	Power	Kelvin	Rated flux	Units
PX-0668-NEG	● Black	6,3W	3000K	750 lm	20



Wall lamp

Outdoor



Wall lamp

Forlight

Auro NEW

STRUCT MAT
Aluminium

DIFF MAT
Polycarbonate

CLASS I
100-240V / 50-60Hz

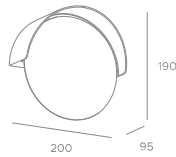

Code	Color	Power	Kelvin	Rated flux	Units
PX-0770-BLA	○ White	6,2W	3000K	827 lm	10
PX-0770-NEG	● Black	6,2W	3000K	827 lm	10



Wall lamp

Outdoor



Wall lamp

Forlight

Creu

STRUCT MAT
Polycarbonate

DIFF MAT
Polycarbonate

CLASS II
220-240V / 50-60Hz



PX-0637

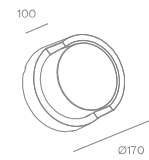

PX-0638

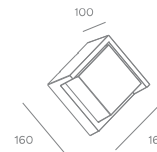

Code	Color	Power	Kelvin	Rated flux	Units
PX-0637-NEG	● Black	15,1W	2700K - 4000K - 6000K	1800 lm*	20
PX-0638-NEG	● Black	15,2W	2700K - 4000K - 6000K	1800 lm*	20

* Value based on 4000K.



Wall lamp

Outdoor



Wall lamp

Forlight

Kairo NEW

STRUCT MAT
ABS

DIFF MAT
Polycarbonate

CLASS II
100-240V / 50-60Hz

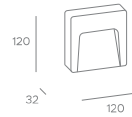

3 covers included



Code	Color	Power	Kelvin	Rated flux	Units
PX-0751-NEG	<input type="radio"/> White / <input type="radio"/> Grey / <input type="radio"/> Black	2,9W	2700K - 3200K - 4000K	343 lm*	20

*Value based on 3200K

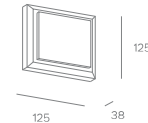

3 covers included



Code	Color	Power	Kelvin	Rated flux	Units
PX-0755-NEG	<input type="radio"/> White / <input type="radio"/> Grey / <input type="radio"/> Black	4W	2700K - 3200K - 4000K	711 lm*	20

*Value based on 3200K



Wall lamp

Outdoor



Wall lamp

Forlight

Kairo NEW

STRUCT MAT
Polycarbonate and ABS

DIFF MAT
Polycarbonate

CLASS II
PX-0752: 220-240VAC / 50-60Hz — PX-0753 - PX-0754: 100-240VAC / 50-60Hz

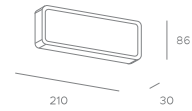

3 covers included



Code	Color	Power	Kelvin	Rated flux	Units
PX-0752-NEG	○ White / ● Grey / ● Black	5,4W	2700K - 3200K - 4000K	614 lm*	18

*Value based on 3200K



PX-0126

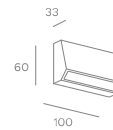

PX-0130

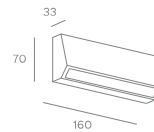

3 covers included



Code	Color	Power	Kelvin	Rated flux	Units
PX-0753-NEG	○ White / ● Grey / ● Black	1,9W	2700K - 3200K - 4000K	225 lm*	40
PX-0754-NEG	○ White / ● Grey / ● Black	3W	2700K - 3200K - 4000K	461 lm*	20

*Value based on 3200K



Wall lamp

Outdoor

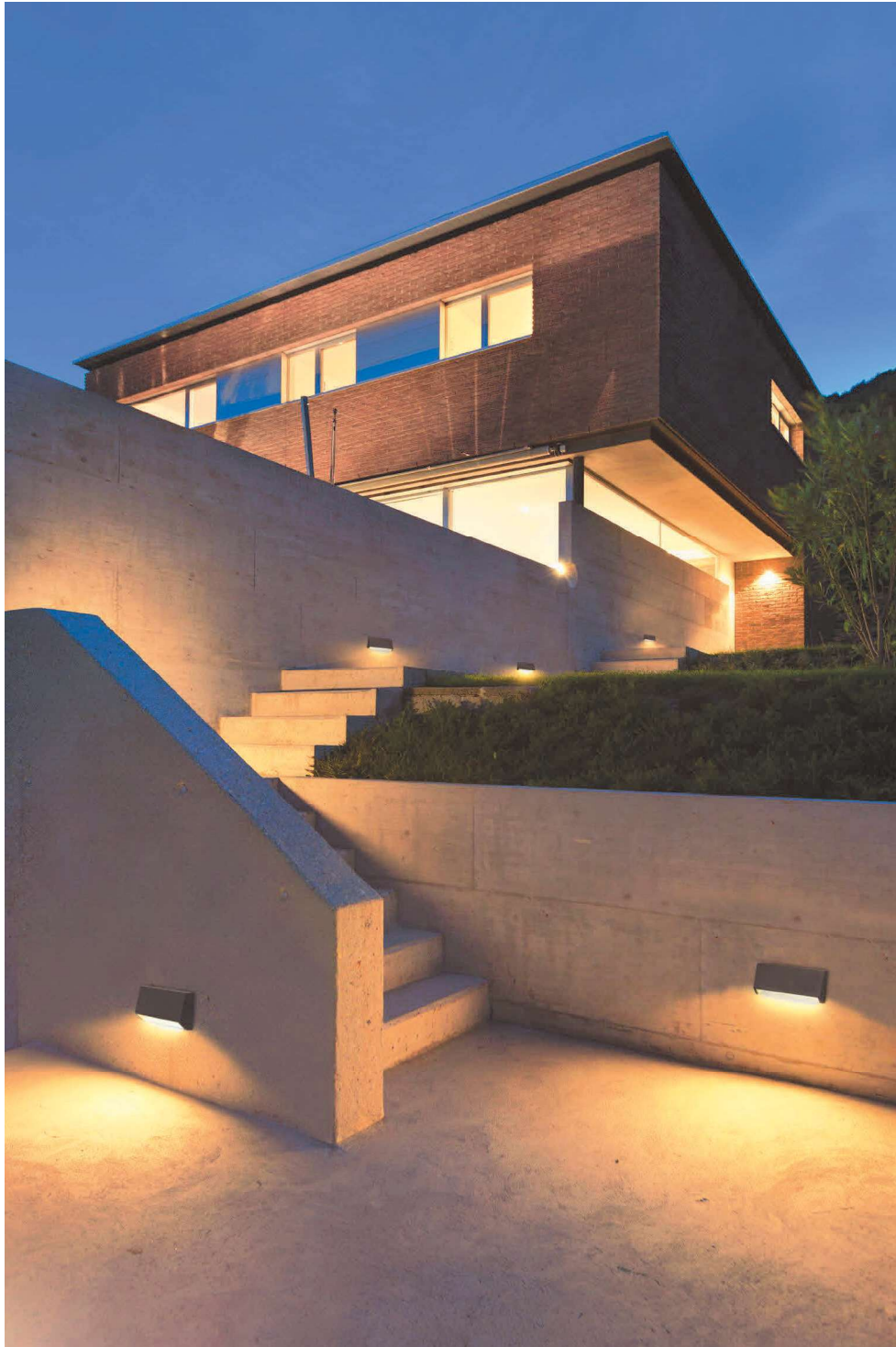

Wall lamp

Forlight

Nod

STRUCT MAT
Aluminium

DIFF MAT
Polycarbonate

CLASS I
220-240V / 50-60Hz



PX-0350



PX-0351



Code	Color	Power	Kelvin	Rated flux	Units
PX-0350-NEG	● Black	2,6W	3000K	210 lm	40
PX-0350-BLA	○ White	2,6W	3000K	210 lm	40
PX-0351-NEG	● Black	2,6W	3000K	210 lm	40
PX-0351-BLA	○ White	2,6W	3000K	210 lm	40



Loyd

STRUCT MAT
Aluminium

DIFF MAT
Glass

CLASS I
100-240V / 50-60Hz



PX-0395



PX-0396

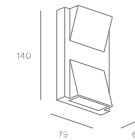

Code	Color	Power	Kelvin	Rated flux	Units
PX-0395-NEG S	● Black	3,4W	3000K	180 lm	20
PX-0396-NEG S	● Black	5,9W	3000K	360 lm	20



Wall lamp

Outdoor

Hide

STRUCT MAT
Aluminium

DIFF MAT
Polycarbonate

CLASS II
220-240V / 50-60Hz



PX-0534



PX-0535

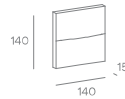

PX-0536

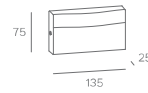

Code	Color	Power	Kelvin	Rated flux	Units
PX-0534-ANT	● Urban grey	2,7W	4000K	268 lm	24
PX-0535-ANT	● Urban grey	2,7W	4000K	268 lm	24
PX-0536-ANT	● Urban grey	8,2W	4000K	812 lm	16



Hide collection

Bollard
P.264



Wall lamp

Forlight

Orion NEW

STRUCT MAT
Aluminium

DIFF MAT
Glass

CLASS I
100-240V / 50-60Hz



PX-0378



PX-0379

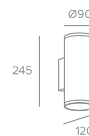

Code	Color	Power	Kelvin	Rated flux	Units
PX-0378-BLA N	○ White	7,3W	3000K	610 lm	10
PX-0378-GRI	● Grey	7,3W	3000K	610 lm	10
PX-0378-NEG	● Black	7,3W	3000K	610 lm	10
PX-0379-BLA N	○ White	13,1W	3000K	1220 lm	10
PX-0379-GRI	● Grey	13,1W	3000K	1220 lm	10
PX-0379-NEG	● Black	13,1W	3000K	1220 lm	10

Orion collection

Surface
mounted
P. 278



Wall lamp

Outdoor



Wall lamp

Forlight

Orion NEW

STRUCT MAT
Aluminium

DIFF MAT
Glass

CLASS I
100-240V / 50-60Hz



PX-0758

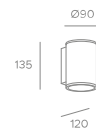

PX-0759



Code	Color	Power	Units
PX-0758-BLA	○ White	Max. 8W (LED)	10
PX-0758-NEG	● Black	Max. 8W (LED)	10
PX-0759-BLA	○ White	2 x Max. 8W (LED)	10
PX-0759-NEG	● Black	2 x Max. 8W (LED)	10

Orion collection

Surface
mounted
P. 278



Wall lamp

Outdoor



Wall lamp

Forlight

Ara

STRUCT MAT
Polycarbonate and ABS

DIFF MAT
Polycarbonate

CLASS II
100-240V / 50-60Hz



PX-0376 / PX-0651

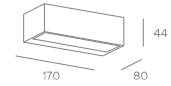

Code	Color	Power	Kelvin	Rated flux	Units
PX-0376-BLA	○ White	9,3W	3000K	820 lm	40
PX-0376-ANT	● Urban grey	9,3W	3000K	820 lm	40
PX-0376-MAR	● Brown	9,3W	3000K	820 lm	40
PX-0651-BLA	○ White	9,3W	4000K	820 lm	40
PX-0651-ANT	● Dark grey	9,3W	4000K	820 lm	40
PX-0651-MAR	● Brown	9,3W	4000K	820 lm	40



PX-0375

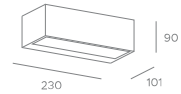

Code	Color	Power	Kelvin	Rated flux	Units
PX-0375-BLA	○ White	Max. 15W (LED)	-	-	16
PX-0375-ANT	● Urban grey	Max. 15W (LED)	-	-	16
PX-0375-MAR	● Brown	Max. 15W (LED)	-	-	16



238
Bulb not included

Wall lamp

Outdoor



Wall lamp

Forlight

Fond NEW

STRUCT MAT
Polipropylene

DIFF MAT
Polycarbonate

CLASS II
100-240V / 50-60Hz



PX-0345

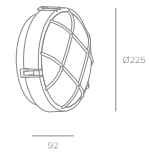

PX-0774

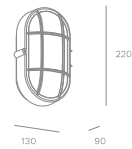

Code	Color	Power	Units
PX-0345-BLA	○ White	Max. 15W (LED)	18
PX-0345-NEG	● Black	Max. 15W (LED)	18
PX-0774-BLA	○ White	Max. 15W (LED)	18
PX-0774-NEG	● Black	Max. 15W (LED)	18



240 Bulb not included

Wall lamp

Outdoor



Wall lamp

Forlight

Cone

STRUCT MAT
ABS

DIFF MAT
Polycarbonate

CLASS II
100-240V / 50-60Hz

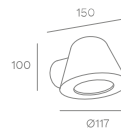

Code	Color	Power	Units
PX-0499-NEG S	● Black	Max. 8W (LED)	20



Bulb not included

242

Cone collection

Bollard
P. 273



Wall lamp

Outdoor

Kala

STRUCT MAT
Aluminium

DIFF MAT
Glass

CLASS I
100-240V / 50-60Hz

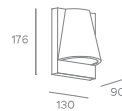

Code	Color	Power	Units
PX-0383-ANT	● Urban grey	Max. 8W (LED)	12



Bulb not included



Kala collection

Bollard
P. 276



Wall lamp

Forlight

Avenue

STRUCT MAT
Steel and Aluminium

DIFF MAT
Glass

CLASS I
100-240V / 50-60Hz

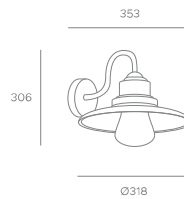

Code	Color	Power	Units
PX-0252-NEG	● Black	Max. 15W (LED)	4



244
Bulb not included

Wall lamp

Outdoor

Alan

STRUCT MAT
Polypropylene

DIFF MAT
Polycarbonate

CLASS II
100-240V / 50-60Hz



PX-0623

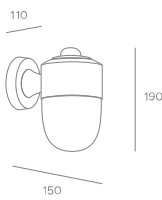

PX-0624

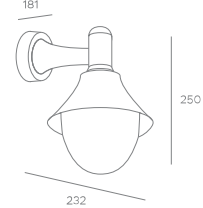

Code	Color	Power	Units
PX-0623-NEG	● Black	Max. 15W (LED)	20
PX-0624-NEG	● Black	Max. 15W (LED)	6



Bulb not included



PX-0623



Wall lamp

Forlight

Foix

STRUCT MAT
ABS

DIFF MAT
Polycarbonate

CLASS II
100-240V / 50-60Hz



PX-0546

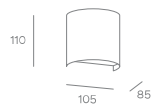

PX-0550

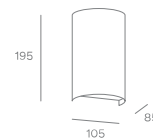

Code	Color	Power	Units
PX-0546-NEG S	● Black	Max. 8W (LED)	20
PX-0550-NEG S	● Black	2x Max. 8W (LED)	24



Bulb not included

Wall lamp

Outdoor

Prisma

STRUCT MAT
Polycarbonate and ABS

DIFF MAT
Polycarbonate

CLASS II
100-240V / 50-60Hz



PX-0545

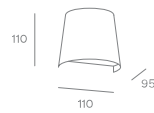

PX-0551

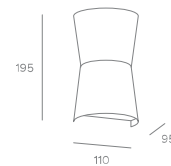

Code	Color	Power	Units
PX-0545-NEG	● Black	Max. 8W (LED)	20
PX-0551-NEG	● Black	2x Max. 8W (LED)	24



Bulb not included



Wall lamp

Forlight

Area

STRUCT MAT
Polycarbonate and ABS

DIFF MAT
Polycarbonate

CLASS II
100-240V / 50-60Hz



Code	Color	Power	Units
PX-0625-BLA	○ White	Max. 15W (LED)	9
PX-0625-GRI	● Grey	Max. 15W (LED)	9
PX-0625-NEG	● Black	Max. 15W (LED)	9



Bulb not included

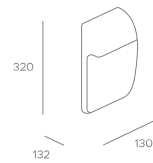

Code	Color	Power	Units
PX-0352-BLA	○ White	Max. 15W (LED)	9
PX-0352-GRI	● Grey	Max. 15W (LED)	9
PX-0352-NEG	● Black	Max. 15W (LED)	9



Bulb not included



Wall lamp

Forlight

Cube

STRUCT MAT
Steel

DIFF MAT
Glass

CLASS I
100-240V / 50-60Hz



PX-0056

PX-0127

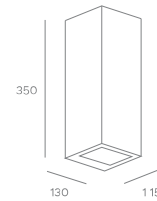
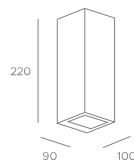

Code	Color	Power	Units
PX-0056-GRI	● Grey	2x Max. 8W (LED)	12
PX-0056-NEG	● Black	2x Max. 8W (LED)	12
PX-0127-NEG	● Black	2x Max. 15W (LED)	8



Bulb not included



Bulb not included

Wall lamp

Outdoor

Kubo

STRUCT MAT
Polycarbonate and ABS

DIFF MAT
Polycarbonate

CLASS II
100-240V / 50-60Hz



PX-0140



PX-0141

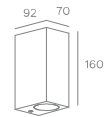

Code	Color	Power	Units
PX-0140-NEG	● Black	Max. 8W (LED)	20
PX-0141-NEG	● Black	2x Max. 8W (LED)	20



Bulb not included



Wall lamp

Forlight

Osaka

STRUCT MAT
Steel

DIFF MAT
Polycarbonate

CLASS I
100-240V / 50-60Hz

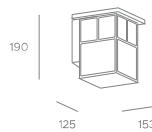

Code	Color	Power	Units
PX-0028-OXI	● Rusty brown	Max. 15W (LED)	6



252
Bulb not included

Wall lamp

Outdoor

Mayor

STRUCT MAT
Aluminium

DIFF MAT
Glass

CLASS I
100-240V / 50-60Hz

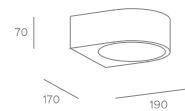

Code	Color	Power	Units
PX-0005-GRI S	● Grey	Max. 15W (LED)	12
PX-0005-ANT	● Anthracite	Max. 15W (LED)	12



Bulb not included



Wall lamp

Forlight

Thomas

STRUCT MAT
Aluminium and Polypropylene

DIFF MAT
Polycarbonate

CLASS I
100-240V / 50-60Hz

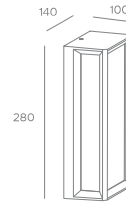

Code	Color	Power	Units
PX-0148-ANT	● Urban grey	Max. 15W (LED)	8



Bulb not included



Siluet

STRUCT MAT
Stainless steel AISI 304

DIFF MAT
Polycarbonate

CLASS II
100-240V / 50-60Hz

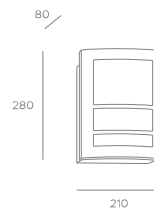
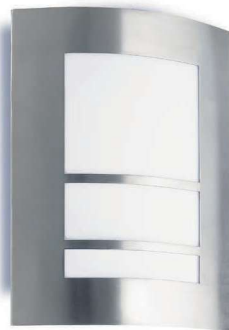

Code	Color	Power	Units
PX-0246-INO S	● Stainless steel	Max. 15W (LED)	6



Bulb not included



Wall lamp

Outdoor

Quanta

STRUCT MAT
Aluminium

DIFF MAT
Polycarbonate

CLASS I
100-240V / 50-60Hz



PX-0644

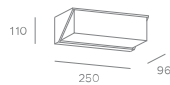

PX-0645

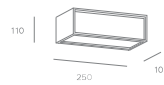

Code	Color	Power	Units
PX-0644-NEG	● Black	Max. 15W (LED)	12
PX-0645-NEG	● Black	Max. 15W (LED)	12



Bulb not included



Wall lamp

Forlight

Veta

STRUCT MAT
Aluminium

DIFF MAT
Polycarbonate

CLASS I
100-240V / 50-60Hz

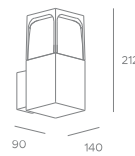
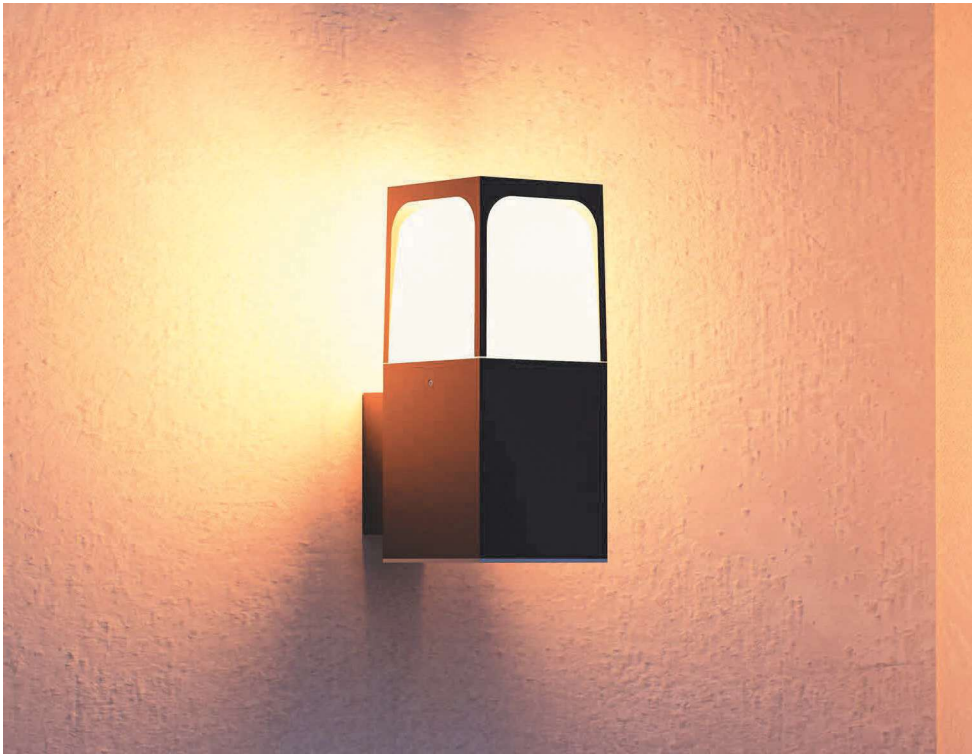

Code	Color	Power	Units
PX-0664-NEG	● Black	Max. 15W (LED)	8



256
Bulb not included

Veta collection

Bollard
P. 270



Wall lamp

Outdoor

Astra

STRUCT MAT
Aluminium

DIFF MAT
Polycarbonate

CLASS I
100-240V / 50-60Hz

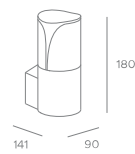

Code	Color	Power	Units
PX-0627-ANT	● Dark grey	Max. 15W (LED)	8



Bulb not included



Astra collection

Bollard
P. 268



Bollard

Forlight

Eclipta I

STRUCT MAT
Aluminium

DIFF MAT
Polycarbonate and glass

CLASS I
220-240V / 50-60Hz

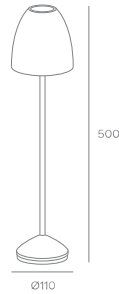

Eclipta I collection

Wall lamp
P. 208



Code	Color	Power	Kelvin	Rated flux	Units
PX-0692-NEG	● Black	10W	3000K	1190 lm	6
PX-0692-MAR	● Brown	10W	3000K	1190 lm	6
PX-0692-VRD	● Green	10W	3000K	1190 lm	6





Bollard

Forlight

Eclipta II

STRUCT MAT
Aluminium

DIFF MAT
Polycarbonate

CLASS I
220-240V / 50-60Hz



Eclipta II collection

Wall lamp
P. 210



Code	Color	Power	Kelvin	Rated flux	Units
PX-0696-NEG	● Black	9W	3000K	1000 lm	12
PX-0696-MAR	● Brown	9W	3000K	1000 lm	12
PX-0696-VRD	● Green	9W	3000K	1000 lm	12



Bollard

Outdoor



Bollard

Forlight

One

STRUCT MAT
Aluminium

DIFF MAT
Polycarbonate

CLASS I
100-240VAC / 50-60Hz



Code	Color	Power	Kelvin	Rated flux	Units
PX-0669-NEG	● Black	6,3W	3000K	750 lm	8



One collection

Wall lamp
P. 222



Bollard

Outdoor



Bollard

Forlight

Hide

STRUCT MAT
Aluminium

DIFF MAT
Polycarbonate

CLASS I
220-240V / 50-60Hz

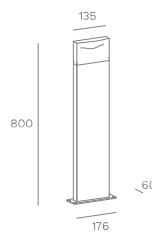

Hide collection

Code	Color	Power	Kelvin	Rated flux	Units
PX-0537-ANT	● Urban grey	8,2W	4000K	812 lm	4

Wall lamp
P. 233



Bollard

Outdoor

Yika

STRUCT MAT
Polycarbonate and ABS

DIFF MAT
Polycarbonate

CLASS II
100-240V / 50-60Hz

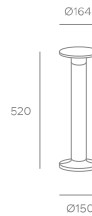

Yika collection

Wall lamp
P. 213



Code	Color	Power	Kelvin	Rated flux	Units
PX-0487-NEG	● Black	7,9W	3000K	690 lm	6



Bollard

Forlight

Arrow

STRUCT MAT
Aluminium

DIFF MAT
Polycarbonate

CLASS I
100-240V / 50-60Hz

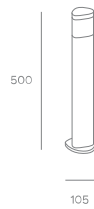

Code	Color	Power	Kelvin	Rated flux	Units
PX-0139-NEG	● Black	6,6W	3000K	640 lm	9



Bollard

Outdoor

Top

STRUCT MAT
Aluminium

DIFF MAT
Tempered glass

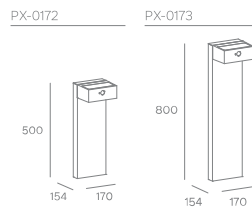

Code	Color	Power	Kelvin	Rated flux	Units
PX-0172-ANT	● Urban grey	3W	3000K	400 lm	4
PX-0173-ANT	● Urban grey	3W	3000K	400 lm	4



Top collection

Wall lamp
P.220



Bollard

Forlight

Astra

STRUCT MAT
Aluminium

DIFF MAT
Polycarbonate

CLASS I
100-277V / 50-60Hz



PX-0628

PX-0629

PX-0630

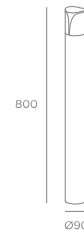
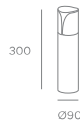

Code	Color	Power	Units
PX-0628-ANT	● Dark grey	Max. 15W (LED)	9
PX-0629-ANT	● Dark grey	Max. 15W (LED)	9
PX-0630-ANT	● Dark grey	Max. 15W (LED)	9

Astra collection

Wall lamp
P. 257



268
Bulb not included



Bollard

Forlight

Veta

STRUCT MAT
Aluminium

DIFF MAT
Polycarbonate

CLASS I
100-240V / 50-60Hz



PX-0665

PX-0666

PX-0667

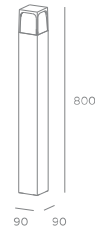
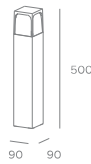
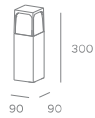

Code	Color	Power	Units
PX-0665-NEG	● Black	Max. 15W (LED)	4
PX-0666-NEG	● Black	Max. 15W (LED)	4
PX-0667-NEG	● Black	Max. 15W (LED)	4

Veta collection

Wall lamp
P. 256



270
Bulb not included

Bollard

Outdoor



Bollard

Forlight

Pixa

STRUCT MAT
Stainless steel AISI 202

DIFF MAT
Glass

CLASS I
100-240V / 50-60Hz

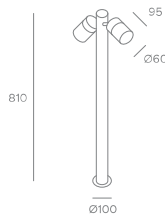

Pixa collection

Spotlight
P. 198



Wall spotlight
P. 202



Code	Color	Power	Units
PX-0524-NEG S	● Black	2x Max. 8W (LED)	4



Bulb not included



Bollard

Outdoor

Cone

STRUCT MAT
ABS

DIFF MAT
Polycarbonate

CLASS II
100-240V / 50-60Hz



PX-0500

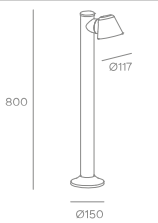

PX-0501

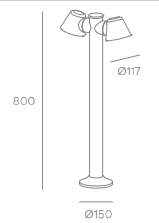

Code	Color	Power	Units
PX-0500-NEG S	● Black	Max. 8W (LED)	6
PX-0501-NEG S	● Black	2x Max. 8W (LED)	4



Bulb not included



Cone collection

Wall lamp
P. 242



Bollard

Forlight

Indoo

STRUCT MAT
Polycarbonate

DIFF MAT
Polycarbonate

CLASS II
100-240V / 50-60Hz



Code	Color	Power	Units
PX-0134-NEG	● Black	Max. 15W (LED)	12



Bulb not included

Bollard

Outdoor

Mandela NEW

STRUCT MAT
Aluminium

DIFF MAT
Polycarbonate

CLASS I
100-240V / 50-60Hz



PX-0757

PX-0086

PX-0087

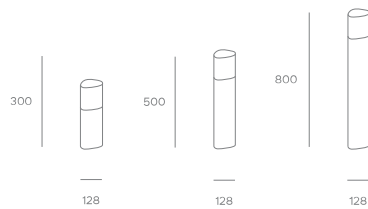

Code	Color	Power	Units
PX-0757-ANT N	● Urban grey	Max. 15W (LED)	6
PX-0086-ANT	● Urban grey	Max. 15W (LED)	6
PX-0087-ANT	● Urban grey	Max. 15W (LED)	6



Bulb not included



Bollard

Forlight

Kala

STRUCT MAT
Aluminium

DIFF MAT
Glass

CLASS I
100-240V / 50-60Hz



PX-0102

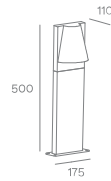

PX-0103

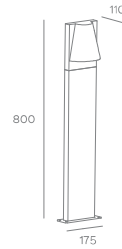

Excellent visual comfort and zero light pollution.

Code	Color	Power	Units
PX-0102-ANT S	● Urban grey	Max. 8W (LED)	4
PX-0103-ANT S	● Urban grey	Max. 8W (LED)	4

Kala collection

Wall lamp
P. 243



Subt not included



Koral

STRUCT MAT
AISI 202 Stainless steel

DIFF MAT
Polycarbonate

CLASS I
100-240V / 50-60Hz



PX-0099

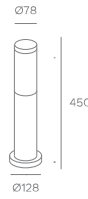

PX-0100



Code	Color	Power	Units
PX-0099-ANT	● Urban grey	Max. 15W (LED)	4
PX-0099-INO	○ Stainless steel	Max. 15W (LED)	4
PX-0100-ANT	● Urban grey	Max. 15W (LED)	4
PX-0100-INO	○ Stainless steel	Max. 15W (LED)	4



Subt not included



Bollard

Outdoor

Siljan

STRUCT MAT
AISI 202 Stainless steel

DIFF MAT
Polycarbonate

CLASS I
100-240V / 50-60Hz

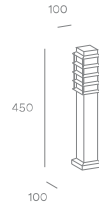

Code	Color	Power	Units
PX-0029-MAR	● Rusty brown	Max. 15W (LED)	12



Bulb not included



IP 55



IK 08

Alfil

STRUCT MAT
Aluminium

DIFF MAT
Glass

CLASS I
100-240V / 50-60Hz

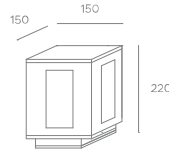

Code	Color	Power	Units
PX-0033-ANT	● Urban grey	Max. 15W (LED)	4



Bulb not included



IP 44



IK 06

Surface mounted

Forlight

Orion NEW

STRUCT MAT
Aluminium

DIFF MAT
Glass

CLASS I
100-240V / 50-60Hz



PX-0380

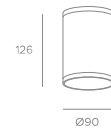

Code	Color	Power	Kelvin	Rated flux	Units
PX-0380-BLA N	○ White	7,3W	3000K	610 lm	20
PX-0380-GRI	● Grey	7,3W	3000K	610 lm	20
PX-0380-NEG	● Black	7,3W	3000K	610 lm	20



PX-0760



Code	Color	Power	Units
PX-0760-BLA N	○ White	Max 8W (LED)	20
PX-0760-NEG N	● Black	Max 8W (LED)	20



278
Bulb not included

Orion collection

Wall lamp
P. 234



Surface mounted

Outdoor

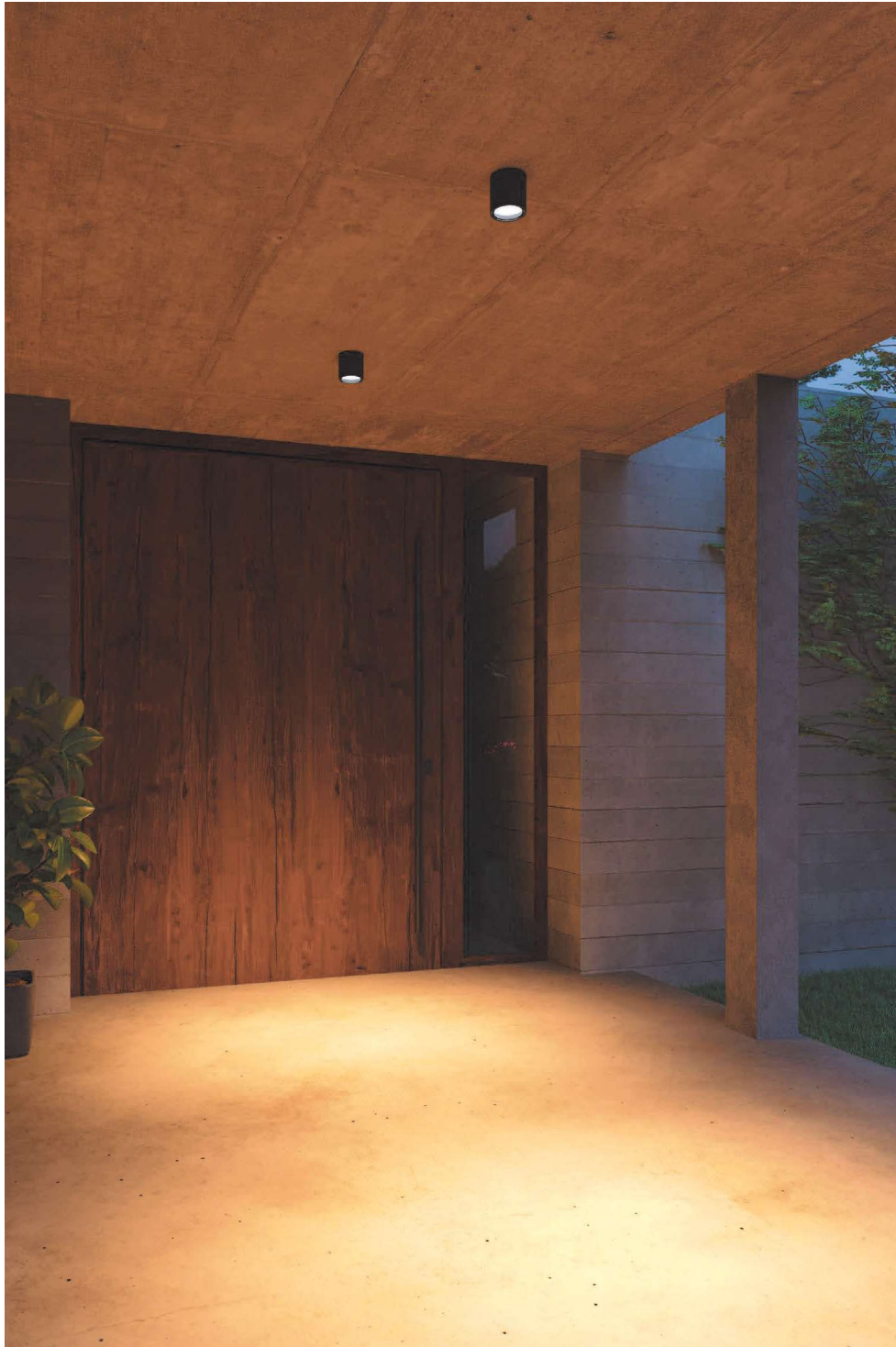

Surface mounted

Forlight

Crest NEW

STRUCT MAT
Aluminium

DIFF MAT
Glass and Polycarbonate

Class I
100-240V / 50-60Hz

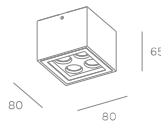

Crest collection

Code	Color	Power	Kelvin	Rated flux	Units
PX-0765-NEG	● Black	8.2W	3000K	800 lm	20



Spotlight
P.184



Surface mounted

Outdoor



Surface mounted

Forlight

Ford

STRUCT MAT
Polycarbonate and ABS

DIFF MAT
Polycarbonate

CLASS II
100-240V / 50-60Hz



Code	Color	Power	Units
PX-1801-BLA 	○ White	2x Max. 15W (LED)	6
PX-1801-GRI 	● Grey	2x Max. 15W (LED)	6



Surface mounted

Outdoor

Scal

STRUCT MAT
Polypropylene

DIFF MAT
Polypropylene

CLASS II
220-240V / 50-60Hz

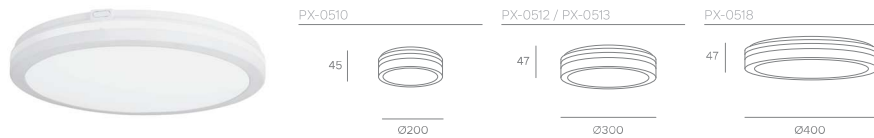

Code	Color	Power	Kelvin	Rated flux	Units
PX-0510-BLA	○ White	14,4W	3000K - 4000K- 6000K	2160 lm*	20
PX-0512-BLA	○ White	23,1W	3000K - 4000K- 6000K	3360 lm*	10
PX-0513-BLA	○ White	23,1W	3000K - 4000K- 6000K	3360 lm*	10
PX-0518-BLA	○ White	32,6W	3000K - 4000K- 6000K	5100 lm*	10

Value based on 4000K.



PX-0513

Pomer	286
Treta	288
Sirina	290
Baser	292
Rorer	294
Deco	296

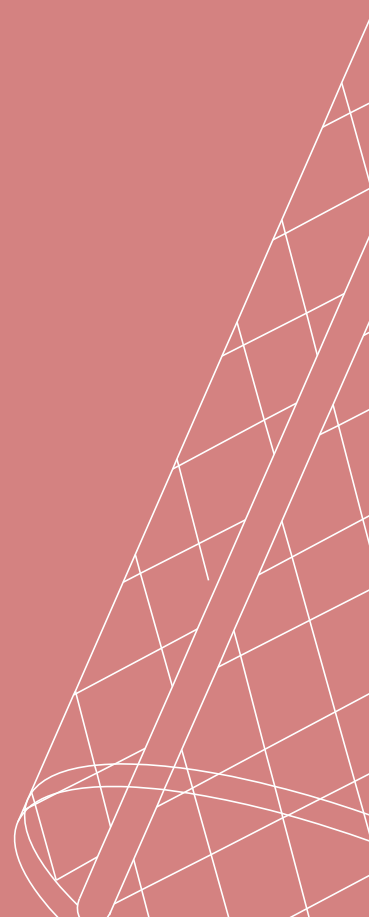

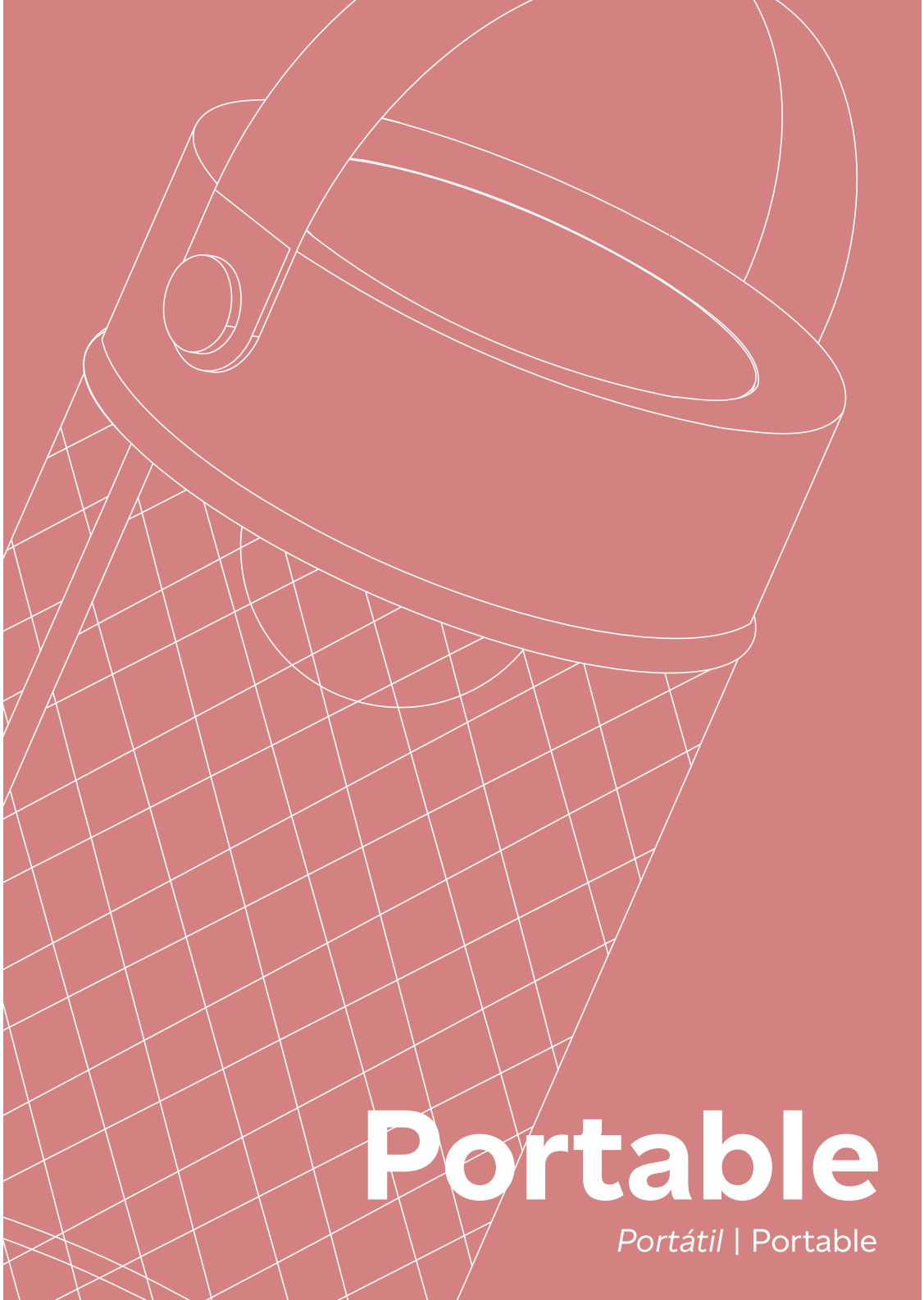

Portable

Portátil | Portable

Portable

Forlight

Pomer

STRUCT MAT
ABS and steel

DIFF MAT
Polycarbonate

CLASS III
5V / 1A

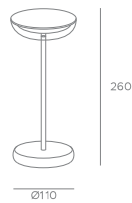

3 brightness settings.



Code	Color	Power	Kelvin	Rated flux	Units
PX-0690-NEG	● Black	1,8W	3000K	180 lm	12
PX-0690-BLA	○ White	1,8W	3000K	180 lm	12



Portable

Portable



Portable

Forlight

Treta

STRUCT MAT
Aluminium

DIFF MAT
Polycarbonate

CLASS III
5V / 1A



PX-0564



PX-0565



3 brightness settings.



Charging by magnetic induction.

Code	Color	Power	Kelvin	Rated flux	Units
PX-0564-NEG	● Black	2W	2700K - 4000K	250 lm*	8
PX-0565-NEG	● Black	2W	2700K - 4000K	250 lm*	8

*Value based on 4000K



Portable

Portable



Portable

Forlight

Sirina

STRUCT MAT
Aluminium

DIFF MAT
Plastic

CLASS III
5V / 1A



3 brightness settings.



Code	Color	Power	Kelvin	Rated flux	Units
PX-0566-NEG	● Black	4W	3000K	506 lm	12



Portable

Portable



Portable

Forlight

Baser

STRUCT MAT
ABS

DIFF MAT
Polyethylene

CLASS III
5V / 1A

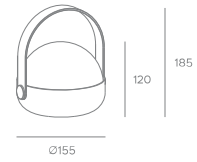

3 brightness
settings.



Code	Color	Power	Kelvin	Rated flux	Units
PX-0698-VRD	● Green	1W	3000K	150 lm	8



Portable

Portable



Portable

Forlight

Rorer

STRUCT MAT
Steel

DIFF MAT
Polycarbonate

CLASS III
5V 1A



3 brightness
settings.



Code	Color	Power	Kelvin	Rated flux	Units
PX-0697-NEG	● Black	3W	3000K	350 lm	18



Portable

Portable



Portable

Forlight

Deco

STRUCT MAT
Steel

DIFF MAT
Polycarbonate

CLASS III
5V / 1A



3 brightness settings.



Handle to adjust brightness levels.

Code	Color	Power	Kelvin	Rated flux	Units
PX-0263-NEG S	● Black	2,8W	3000K	280 lm	8



Portable

Portable



Ventiladores
Ceiling fans
Ventilateurs de plafond

Stem Evo	N	302
Stem		310
Bosc	N	312
Pam	N	314
Helix	N	316
Shadow	N	318
Bora		320
Lace		322
Garbí		324
Calar		326
July		328
Windy		330
Nepal		332
Phuket		334
Formentera		336
Bambu		338
Mim		339
Cil		340
Merak		341
Borneo		342
Mogan		344
Rodas		346
Kudari		347
Klar		348
Zonda		348
Accessories		349

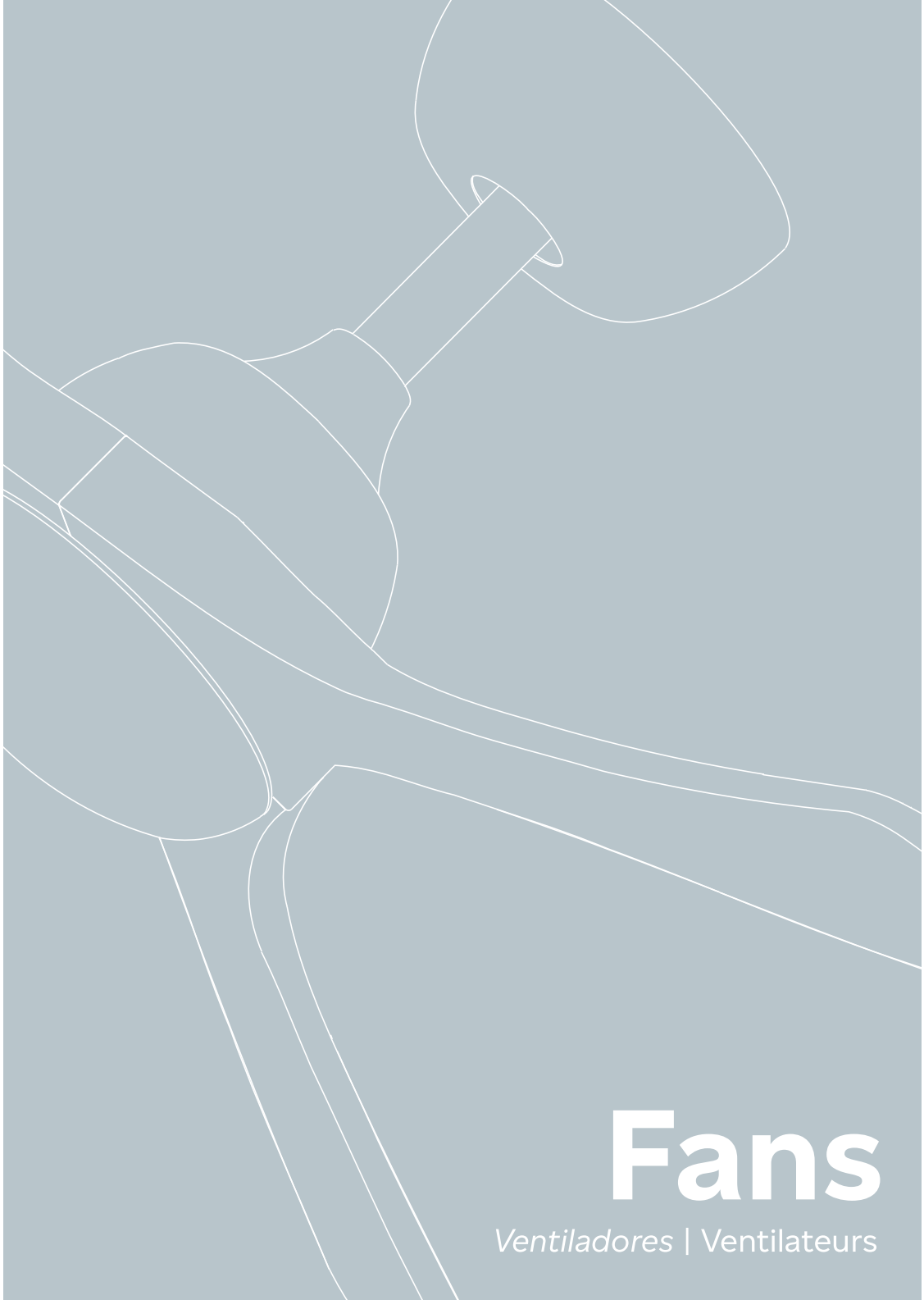

Fans

Ventiladores | Ventilateurs

3 Pasos para elegir tu ventilador

3 Steps to choose your fan

3 étapes pour choisir votre ventilateur

1

Tipo de estancia

Type of stay

Type de séjour

Tamaño

Lo más importante para elegir tu ventilador es saber dónde quieres ubicarlo, en función de la estancia escogeremos el tamaño del ventilador.

Size

The most important thing to choose your fan is to know where you want to place it, depending on the room we will choose the size of the fan.

Taille

Le plus importante pour choisir votre ventilateur est de savoir où vous voulez le placer, en fonction de la pièce nous choisirons la taille du ventilateur.

< 13 m²13 m² - 20 m²20 m² - 32 m²+ 32 m²

2

Con luz o sin luz

With or without light

Avec ou sans lumière

Iluminación

Es muy importante saber si queremos iluminar la estancia.

Lighting

It is very important to know if we want to illuminate the room.

L'éclairage

Il est très important de savoir si l'on souhaite éclairer la pièce.



Con luz
With light
Lumière incl.



Sin luz
Without light
Lumière non incl.

3 Tipo de flujo Type of flow Type de flux

Flujo de aire

Tenemos que seleccionar también el tipo de flujo de aire que deseamos.

Air flow

We must also select the type of air flow we want.

Débit d'air

Nous devons sélectionner le type de flux d'air que nous voulons.



Flujo concentrado
Concentrated flow
Flux concentré



Flujo amplio
Large flow
Débit Large



Movimiento directo y concentrado de aire. Ideal para estancias pequeñas o para refrescar una zona concreta.
Direct and concentrated air movement. Ideal for small rooms or for cooling a specific area.
Mouvement d'air direct et concentré. Idéal pour les petites pièces petites pièces ou pour rafraîchir une zone spécifique.



Movimiento de aire con gran cobertura. Ideal para estancias grandes.
Air movement with great coverage. Ideal for large rooms.
Mouvement d'air avec une grande couverture. Idéal pour les grandes pièces.

Consejos de instalación *Installation tips* Conseils d'installation

Altura
Height
Hauteur

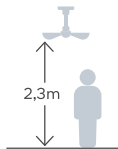

Instalación en techos con pendiente máxima de 15°.

To be installed on ceilings with 15° maximum inclination.

Installation sur plafonds à inclinaison maximum de 15°.

Instalación

Fije correctamente el soporte y las palas. Utilice los contrapesos en caso de balanceo. Finalmente tenga en cuenta que es necesario un período de 24h de asentamiento.

Installation

Fix the support and the blades correctly. If it is unstable, please use the counterweights. It requires 24h settling period.

Installation

Fixez correctement le support et les pales. Utilisez les contrepoids en cas de balancement. Enfin, gardez à l'esprit qu'une période de tassement de 24 heures est nécessaire.

Stem Evo NEW

STRUCT MAT
Steel

DIFF MAT
Glass

BLA MAT
Solid Wood

CLASS I
100-240VAC / 50-60Hz

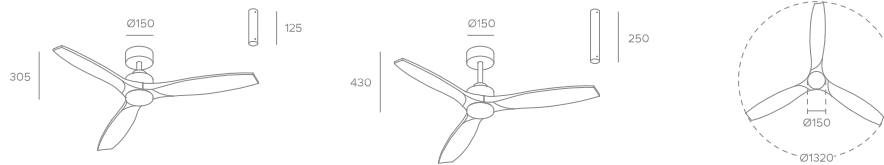

Speed	1	2	3	4	5	6
RPM	82	106	123	148	166	190
W	3,2	5,5	8	13,9	20,4	30

Code	Structure color	Blade color	Power	Kelvin	Rated flux
VE-0095-BBL	○ White	○ White	50W / Motor power 30W + 20W (LED)	3000K - 4000K - 5000K	2875 lm*
VE-0095-BFC	○ White	● Light wood	50W / Motor power 30W + 20W (LED)	3000K - 4000K - 5000K	2875 lm*
VE-0095-NNE	● Black	● Black	50W / Motor power 30W + 20W (LED)	3000K - 4000K - 5000K	2875 lm*
VE-0095-NFF	● Black	● Dark wood	50W / Motor power 30W + 20W (LED)	3000K - 4000K - 5000K	2875 lm*
VE-0095-BNE	○ White	● Black	50W / Motor power 30W + 20W (LED)	3000K - 4000K - 5000K	2875 lm*
VE-0095-BFF	○ White	● Dark wood	50W / Motor power 30W + 20W (LED)	3000K - 4000K - 5000K	2875 lm*
VE-0095-NBL	● Black	○ White	50W / Motor power 30W + 20W (LED)	3000K - 4000K - 5000K	2875 lm*
VE-0095-NFC	● Black	● Light wood	50W / Motor power 30W + 20W (LED)	3000K - 4000K - 5000K	2875 lm*

* Value based on 4000K.

Included	Description	Not included	Code	Description
	125mm bar		71-8504-00-00	Wall controller for DC motor with light
	250mm bar		71-B940-14-14 71-B940-05-05	White 500mm bar Black 500mm bar





Stem Evo NEW

STRUCT MAT
Steel

DIFF MAT
Glass

BLA MAT
Solid Wood

CLASS I
100-240VAC / 50-60Hz

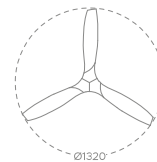
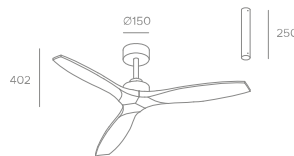
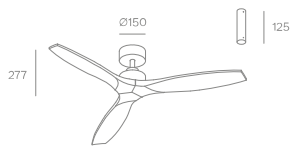

Speed	1	2	3	4	5	6
RPM	82	106	123	148	166	190
W	3,2	5,5	8	13,9	20,4	30

Code	Structure color	Blade color	Power
VE-0096-BBL	○ White	○ White	30W
VE-0096-BFC	○ White	● Light wood	30W
VE-0096-NNE	● Black	● Black	30W
VE-0096-NFF	● Black	● Dark wood	30W
VE-0096-BNE	○ White	● Black	30W
VE-0096-BFF	○ White	● Dark wood	30W
VE-0096-NBL	● Black	○ White	30W
VE-0096-NFC	● Black	● Light wood	30W

Included	Description	Not included	Code	Description
	125mm bar		71-8505-00-00	Wall controller for DC motor without light
	250mm bar		71-B940-14-14 71-B940-05-05	White 500mm bar Black 500mm bar





Stem Evo NEW

STRUCT MAT
Steel

DIFF MAT
Glass

BLA MAT
Solid Wood

CLASS I
100-240VAC / 50-60Hz

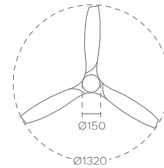
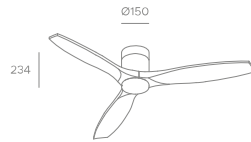

Speed	1	2	3	4	5	6
RPM	82	106	123	148	166	190
W	3,2	5,5	8	13,9	20,4	30

Code	Structure color	Blade color	Power	Kelvin	Rated flux
VE-0097-BBL	○ White	○ White	50W / Motor power 30W + 20W (LED)	3000K - 4000K - 5000K	2875 lm*
VE-0097-BFC	○ White	● Light wood	50W / Motor power 30W + 20W (LED)	3000K - 4000K - 5000K	2875 lm*
VE-0097-NNE	● Black	● Black	50W / Motor power 30W + 20W (LED)	3000K - 4000K - 5000K	2875 lm*
VE-0097-NFF	● Black	● Dark wood	50W / Motor power 30W + 20W (LED)	3000K - 4000K - 5000K	2875 lm*
VE-0097-BNE	○ White	● Black	50W / Motor power 30W + 20W (LED)	3000K - 4000K - 5000K	2875 lm*
VE-0097-BFF	○ White	● Dark wood	50W / Motor power 30W + 20W (LED)	3000K - 4000K - 5000K	2875 lm*
VE-0097-NBL	● Black	○ White	50W / Motor power 30W + 20W (LED)	3000K - 4000K - 5000K	2875 lm*
VE-0097-NFC	● Black	● Light wood	50W / Motor power 30W + 20W (LED)	3000K - 4000K - 5000K	2875 lm*

* Value based on 4000K.

Not included	Code	Description
	71-8504-00-00	Wall controller for DC motor with light



Ceiling fans

Fans



Stem Evo NEW

STRUCT MAT
Steel

DIFF MAT
Glass

BLA MAT
Solid Wood

CLASS I
100-240VAC / 50-60Hz



VE-0098-NBL



VE-0098-NFC



VE-0098-NNE



VE-0098-BBL



VE-0098-BFF



VE-0098-BNE

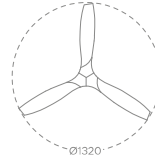
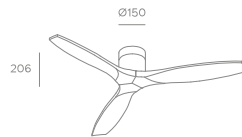

Speed	1	2	3	4	5	6
RPM	82	106	123	148	166	190
W	3,2	5,5	8	13,9	20,4	30

Code	Structure color	Blade color	Power
VE-0098-BBL	○ White	○ White	30W
VE-0098-BFC	○ White	● Light wood	30W
VE-0098-NNE	● Black	● Black	30W
VE-0098-NFF	● Black	● Dark wood	30W
VE-0098-BNE	○ White	● Black	30W
VE-0098-BFF	○ White	● Dark wood	30W
VE-0098-NBL	● Black	○ White	30W
VE-0098-NFC	● Black	● Light wood	30W

Not included	Code	Description
	71-8505-00-00	Wall controller for DC motor without light



Ceiling fans

Fans



Stem

STRUCT MAT
Steel

DIFF MAT
Glass

BLA MAT
Wood

CLASS I
220-240V / 50-60Hz



30-8644

Speed	1	2	3	4	5
RPM	92	112	138	157	190
W	6,4	9,2	15,6	22	33,5

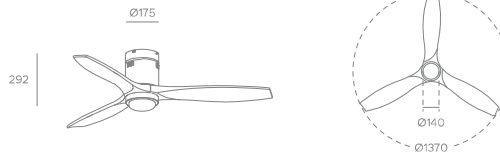

Code	Structure color	Blade color	Power	Kelvin	Rated flux
30-8644-81-92	<input checked="" type="radio"/> Satin	Dark wood	51.5W / Motor power 33.5W + 18W (LED)	3000K - 4000K - 5000K	2589 lm*
30-8644-81-93	<input checked="" type="radio"/> Satin	Light wood	51.5W / Motor power 33.5W + 18W (LED)	3000K - 4000K - 5000K	2589 lm*

* Value based on 4000K.



Speed	1	2	3	4	5
RPM	92	112	138	157	190
W	6,4	9,2	15,6	22	33,5

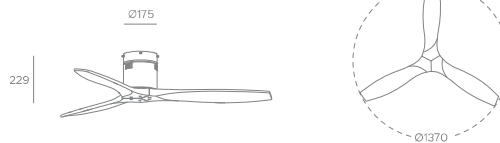

Code	Structure color	Blade color	Power
30-8645-81-92	<input checked="" type="radio"/> Satin	Dark wood	33.5W
30-8645-81-93	<input checked="" type="radio"/> Satin	Light wood	33.5W





Bosc NEW

STRUCT MAT
Steel

DIFF MAT
Acrylic

BLA MAT
Wood

CLASS I
100-240V / 50-60Hz

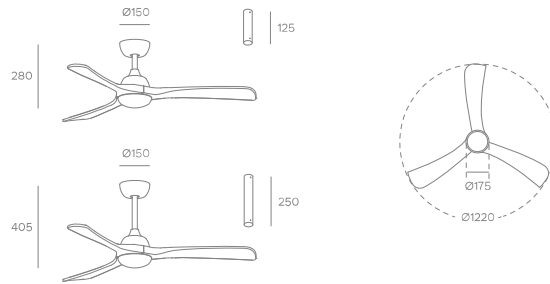

Speed	1	2	3	4	5	6
RPM	91	108	134	156	178	200
W	3,3	4,8	8,3	13	19,3	30

Code	Structure color	Blade color	Power	Kelvin	Rated flux
VE-0092-NEG	● Black	● Dark wood	50W / Motor power 30W + 20W (LED)	3000K - 4000K - 5000K	2875lm*

* Value based on 4000K.

Included	Description	Not included	Code	Description
	125mm bar		71-8504-00-00	Wall controller for DC motor with light
	250mm bar		71-B940-05-05	Black 500mm bar





Pam NEW

STRUCT MAT
Steel

DIFF MAT
Acrylic

BLA MAT
Polycarbonate

CLASS I
100-240V / 50-60Hz

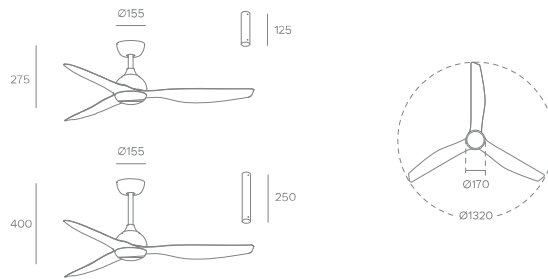

Speed	1	2	3	4	5	6
RPM	85	109	124	145	164	193
W	3,7	5,9	7,8	12,1	18,2	30,8

Code	Structure color	Blade color	Power	Kelvin	Rated flux
VE-0091-BLA	○ White	○ White	50W / Motor power 30W + 20W (LED)	3000K - 4000K - 5000K	2875lm*

* Value based on 4000K.

Included	Description	Not included	Code	Description
	125mm bar		71-8504-00-00	Wall controller for DC motor with light
	250mm bar		71-B940-14-14	White 500mm bar





Helix NEW

STRUCT MAT
Steel

DIFF MAT
Glass

BLA MAT
ABS

CLASS I
100-240V / 50-60Hz

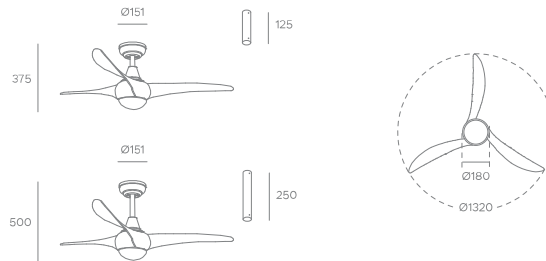

Speed	1	2	3	4	5	6
RPM	78	98	118	136	160	180
W	3,2	5,45	8,5	13,3	20	30

Code	Structure color	Blade color	Power	Kelvin	Rated flux
VE-0094-BLA	○ White	○ White	50W / Motor power 30W + 20W (LED)	3000K - 4000K - 5000K	2875 lm*

* Value based on 4000K.

Included	Description	Not included	Code	Description
	125mm bar		71-8504-00-00	Wall controller for DC motor with light
	250mm bar		71-B940-14-14	White 500mm bar





Shadow NEW

STRUCT MAT
Steel

BLA MAT
ABS

CLASS I
100-240V / 50-60Hz

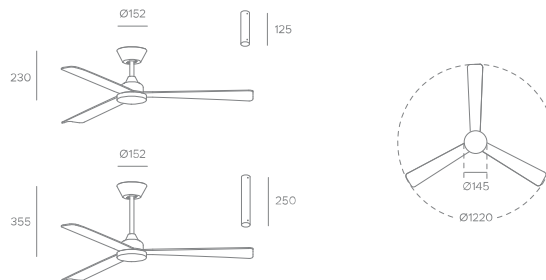

Speed	1	2	3	4	5	6
RPM	103	128	150	167	194	223
W	3,4	5,8	8,6	11,6	18,3	30

Code	Structure color	Blade color	Power
VE-0093-MAR	● Black	● Dark wood	30W

Included	Description	Not included	Code	Description
	125mm bar		71-8505-00-00	Wall controller for DC motor without light
	250mm bar		71-B940-05-05	Black 500mm bar





Bora

STRUCT MAT
Steel

DIFF MAT
Glass

BLA MAT
Polycarbonate

CLASS I
220-240V / 50-60Hz

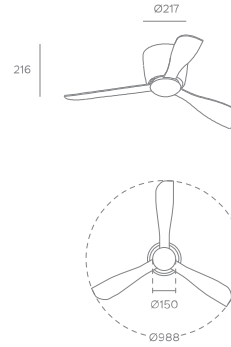

Speed	1	2	3	4	5
RPM	160	175	190	215	240
W	7,3	9,2	11,2	15,3	20,1

Code	Structure color	Blade color	Power	Kelvin	Rated flux
30-7973-14-F9	○ White	○ White	38,1W / Motor power 20,1W + 18W (LED)	3000K	1800 lm

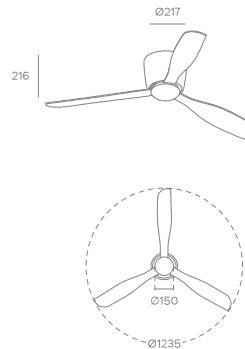

Speed	1	2	3	4	5
RPM	113	128	153	168	183
W	7,8	11	18,5	25,5	33,7

Code	Structure color	Blade color	Power	Kelvin	Rated flux
30-7972-14-F9	○ White	○ White	51,7W / Motor power 33,7W + 18W (LED)	3000K	1800 lm



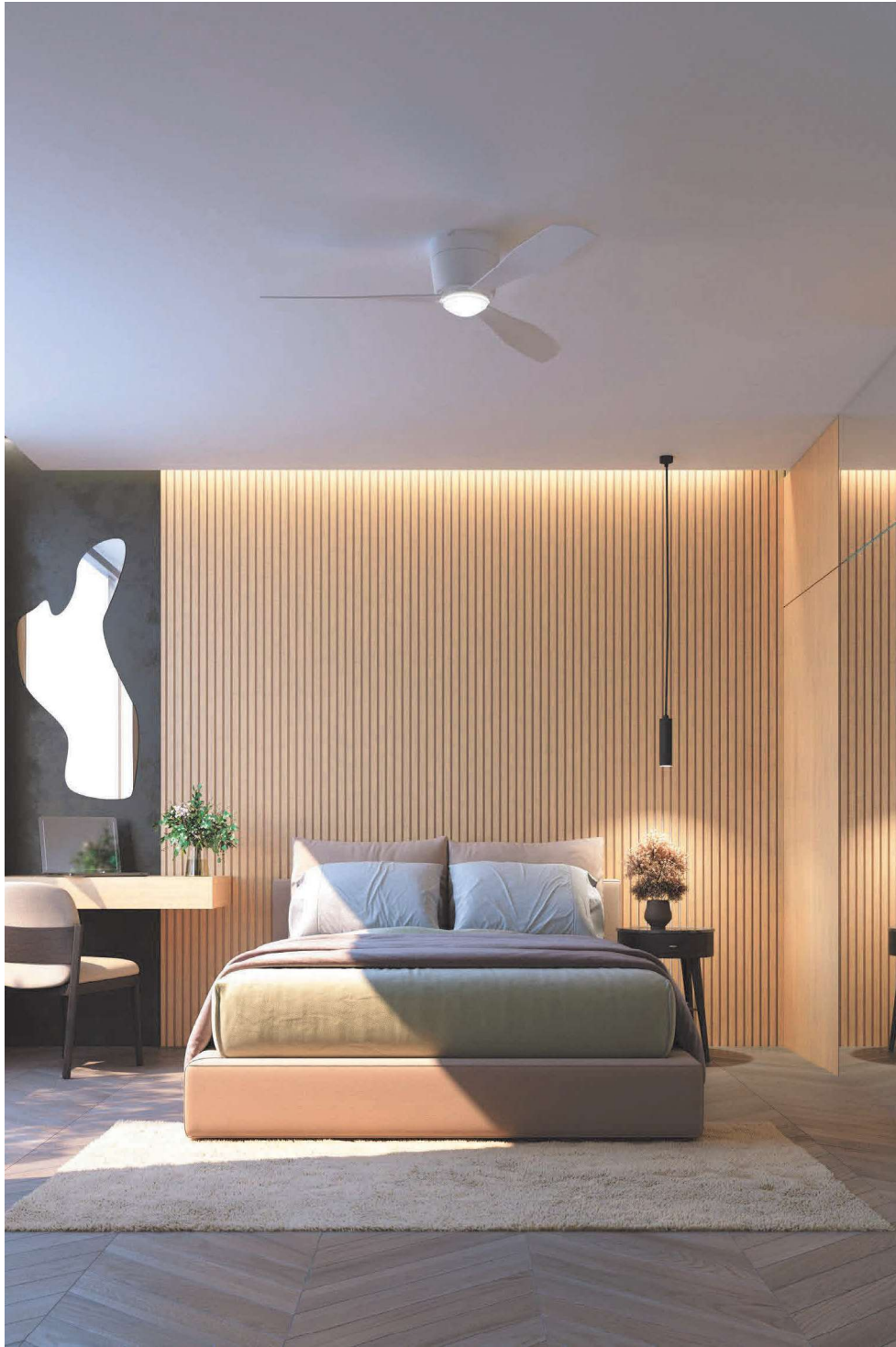

Ceiling fans

Forlight

Lace

STRUCT MAT
Steel

BLA MAT
Steel

CLASS I
100-240V / 50-60Hz

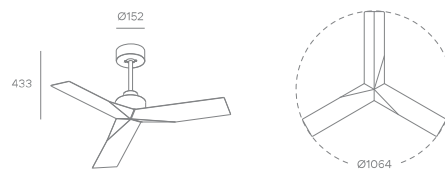

Speed	1	2	3	4	5
RPM	136	180	206	236	266
W	3,8	6,5	9,2	13,5	22,6

Code	Structure color	Blade color	Power
VE-0007-BLA	○ White	○ White	22,6W





Ceiling fans

Forlight

Garbí

STRUCT MAT
Steel

DIFF MAT
Glass

BLA MAT
Acrylic

CLASS I
110-240V / 50-60Hz

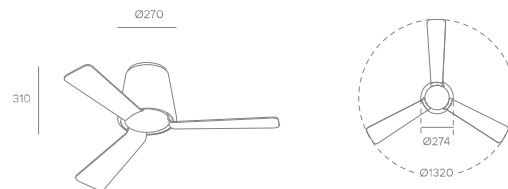

Speed	1	2	3	4	5
RPM	110	138	165	193	221
W	4,1	5,8	11,2	18,5	30

Code	Structure color	Blade color	Power	Kelvin	Rated flux
30-5378-14-F9	○ White	○ Transparent	30W / Motor power 30W + 15W (LED)	3000K	1400 lm





Calar

STRUCT MAT
Steel and aluminium

DIFF MAT
Methacrylate

BLA MAT
FSC wood

CLASS I
200-240VAC / 50-60Hz



Speed	1	2	3	4	5
RPM	80	110	139	172	200
W	3,8	6,5	13,1	24,7	41,9

20-32m² **AIRFLOW 9540 m³/h**

VE-0023

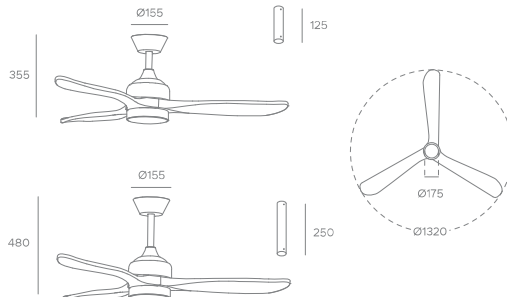





Speed	1	2	3	4	5
RPM	82	122	164	208	250
W	3,7	5,6	9,7	17,6	30,2

13-20m² **AIRFLOW 8220 m³/h**

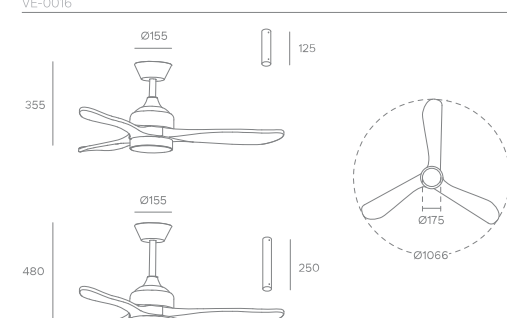
VE-0016





Speed	1	2	3	4	5
RPM	83	147	213	283	352
W	2,1	3	5,4	9,5	19

1-13m² **AIRFLOW 7860 m³/h**

VE-0022

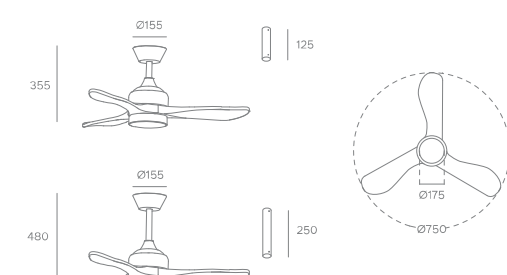

Code	Structure color	Blade color	Power	Kelvin	Rated flux
VE-0023-BLA	○ White	● Light wood	65,9W / Motor power 41,9w + 24W (LED)	3000K - 4000K - 6000K	2570 lm*
VE-0016-BLA	○ White	● Light wood	54,2W / Motor power 30,2w + 24W (LED)	3000K - 4000K - 6000K	2570 lm*
VE-0022-BLA	○ White	● Light wood	43W / Motor power 19W + 24W (LED)	3000K - 4000K - 6000K	2570 lm*

* Value based on 4000K.



Ceiling fans

Fans



July

STRUCT MAT
Steel and aluminium

DIFF MAT
Methacrylate

BLA MAT
ABS

CLASS I
200-240VAC / 50-60Hz

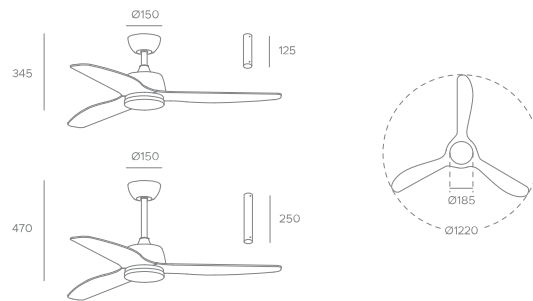

Speed	1	2	3	4	5
RPM	83	112	140	173	200
W	3,3	5,5	9,1	15,5	23,5

Code	Structure color	Blade color	Power	Kelvin	Rated flux
VE-0020-NEG	Black	Wood	47,5W/Motor power 23,5W + 24W (LED)	3000K - 4000K - 6000K	2570 lm*

* Value based on 4000K.

Included	Description
	125mm bar
	250mm bar





Windy

STRUCT MAT
Steel

DIFF MAT
Glass

BLA MAT
Wood

CLASS I
220-230-240V / 50-60Hz

Speed	1	2	3
RPM	85	145	225
W	6	16	43

Code	Structure color	Blade color	Power
VE-0005-BLA	○ White	● Light wood / ○ White	73W / Motor power 43W + 2x Max. 15W (LED)

Not included	Code	Description
	71-4932-00-00	Wall controller for AC motor with light

Speed	1	2	3
RPM	85	145	225
W	6	16	43

Code	Structure color	Blade color	Power
VE-0004-BLA	○ White	● Light wood / ○ White	43W

Not included	Code	Description
	71-4933-00-00	Wall controller for AC motor without light



Ceiling fans

Forlight

Nepal

STRUCT MAT
Steel

DIFF MAT
Glass

BLA MAT
ABS

CLASS I
220-240V / 50-60Hz

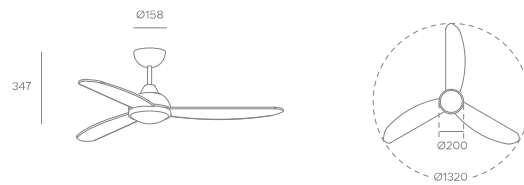

Speed	1	2	3	4	5
RPM	131	142	170	187	200
W	8	11	18	24	33

Code	Structure color	Blade color	Power	Kelvin	Rated flux
30-7644-CF-F9	○ White	○ White	47,5W / Power motor 33W + 14,5W (LED)	3000K	1750 lm



Ceiling fans

Fans



Ceiling fans

Forlight

Phuket

STRUCT MAT
Steel

DIFF MAT
Acrylic

CLASS I
220-240V / 50-60Hz

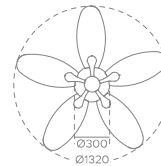
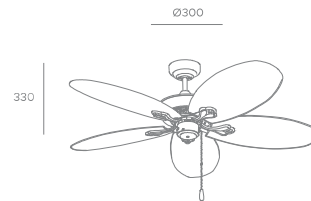

Speed	1	2	3
RPM	80	120	175
W	14	28	56

Code	Structure color	Blade color	Power
30-4398-J7-J7	● Brown	● Dark brown	56W
30-4398-16-16	○ White	● Light brown	56W

Not included	Code	Description
	71-4933-00-00	Wall controller for AC motor without light





Formentera

STRUCT MAT
Aluminium

DIFF MAT
Steel

BLA MAT
Polycarbonate

CLASS I
220-240V / 50-60Hz

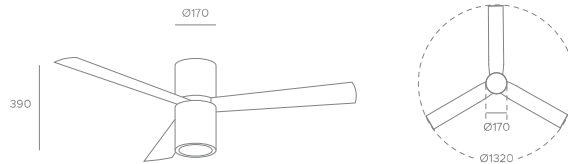
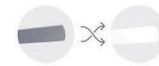

Speed	1	2	3
RPM	100	150	200
W	19	36	66

Code	Structure color	Blade color	Power
30-4393-N3-M1	● Satin	● Satin / ○ White	81W / Motor power 66W + Max. 15W (LED)*
30-4393-CF-M1	○ White	● Satin / ○ White	81W / Motor power 66W + Max. 15W (LED)*

* L=140mm / Ø56mm

Not included	Code	Description
	71-4393-N3-N3 S	White light kit for 30-4393-N3-M1
	71-4932-00-00	Wall controller for AC motor with light
	71-4933-00-00	Wall controller for AC motor without light

+ Info P. 349



Bulb not included



AIRFLOW
9339
m³/h



MOTOR
AC





Bambu

STRUCT MAT
Steel

DIFF MAT
Acrylic

BLA MAT
ABS

SCREEN MAT
Imit bamboo

CLASS I
220-240V / 50-60Hz

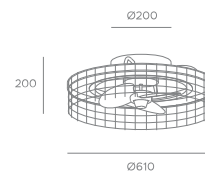

Speed	1	2	3	4	5	6
RPM	612	704	812	910	1012	1118
W	4	4,8	5,7	6,5	8,2	10

Code	Structure color	Blade color	Power	Kelvin	Rated flux
VE-0035-MAD S	Light Wood	Light wood	38 W / Motor power 10W + 28W (LED)	2700K - 6000K	4370 lm*

* Value based on 4000K.



Mim

STRUCT MAT
Steel

DIFF MAT
Acrylic

BLA MAT
ABS

SCREEN MAT
Natural rope

CLASS I
220-240V / 50-60Hz

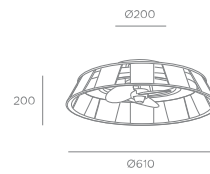

Speed	1	2	3	4	5	6
RPM	612	704	812	910	1012	1118
W	4	4,8	5,7	6,5	8,2	10

Code	Structure color	Blade color	Power	Kelvin	Rated flux
VE-0033-MAD S	● Light wood	● Light wood	38 W / Motor power 10W + 28W (LED)	2700K - 6000K	4370 lm*

* Value based on 4000K.



Cil

STRUCT MAT
Steel

DIFF MAT
Acrylic

BLA MAT
ABS

SCREEN MAT
Steel

CLASS I
220-240V / 50-60Hz

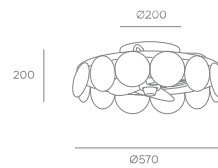

Speed	1	2	3	4	5	6
RPM	612	704	812	910	1012	1118
W	4	4,8	5,7	6,5	8,2	10

Code	Structure color	Blade color	Power	Kelvin	Rated flux
VE-0034-NEG S	● Black	● Black	38 W / Motor power 10W + 28W (LED)	2700K - 6000K	4370 lm*

* Value based on 4000K.



Ceiling fans

Fans

Merak

STRUCT MAT
Steel

DIFF MAT
Acrylic

BLA MAT
ABS

SCREEN MAT
Steel

CLASS I
220-240V / 50-60Hz

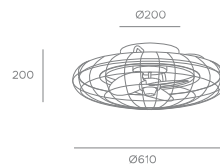
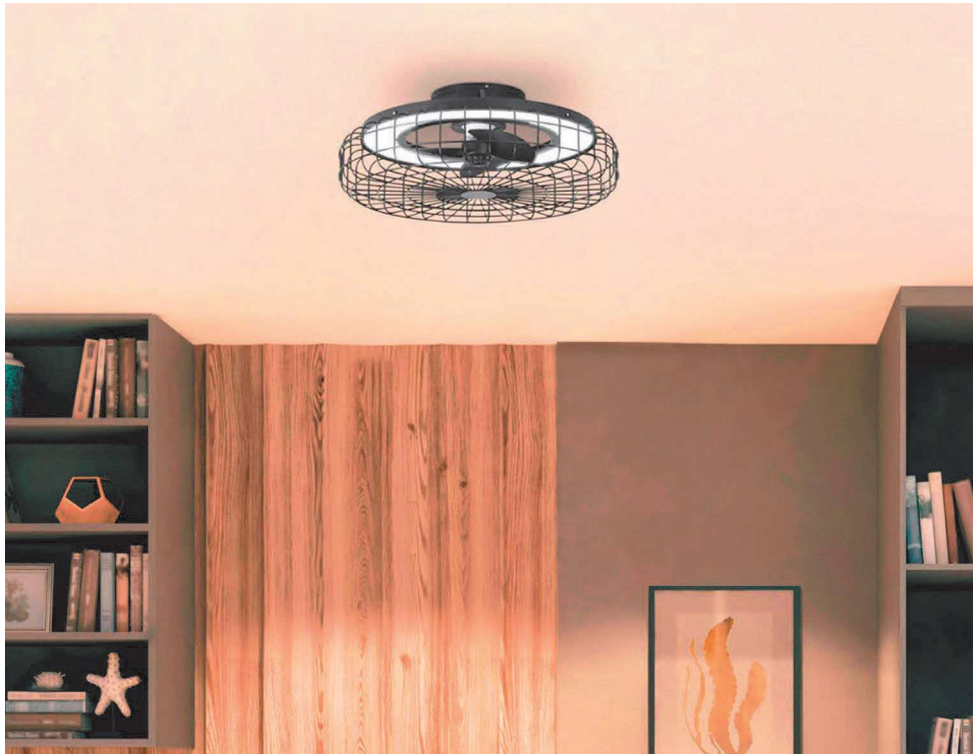

Speed	1	2	3	4	5	6
RPM	612	704	812	910	1012	1118
W	4	4,8	5,7	6,5	8,2	10

Code	Structure color	Blade color	Power	Kelvin	Rated flux
VE-0028-NEG S	● Black	● Black	38 W / Motor power 10W + 28W (LED)	2700K - 6000K	4370 lm*

* Value based on 4000K.



Borneo

STRUCT MAT
Steel

DIFF MAT
Glass

BLA MAT
Wood

CLASS I
230V/50Hz

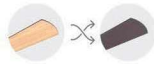
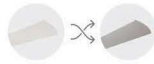

Speed	1	2	3
RPM	100	145	185
W	12	21	40

392

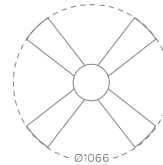
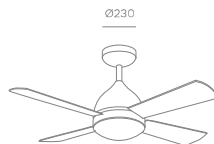

Code	Structure color	Blade color	Power
VE-0006-BLA	○ White	○ White / ● Satin	70W / Motor power 40W + 2x Max. 15W (LED)
VE-0006-SAT	● Satin	● Satin / ○ White	70W / Motor power 40W + 2x Max. 15W (LED)
VE-0006-MAR	● Brown	● Brown / ● Light wood	70W / Motor power 40W + 2x Max. 15W (LED)
VE-0006-PAT	● Satin	● Patina / ● Light wood	70W / Motor power 40W + 2x Max. 15W (LED)

Not included	Code	Description
	71-4932-00-00	Wall controller for AC motor with light
	71-1844-81-81	Satin nickel 460mm bar compatible with AC Motor



Bulb not included





Mogan

STRUCT MAT
Steel and aluminium

BLA MAT
Steel

CLASS I
230V / 50Hz

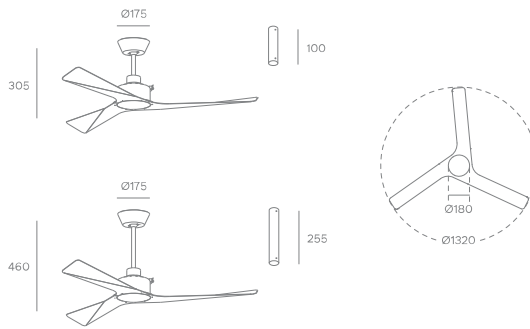

Speed	1	2	3
RPM	140	200	230
W	20	35	65

Code	Structure color	Blade color	Power
30-4356-CF-CF	○ White	○ White	65W

Not included	Code	Description
	71-4933-00-00	Wall controller for AC motor without light



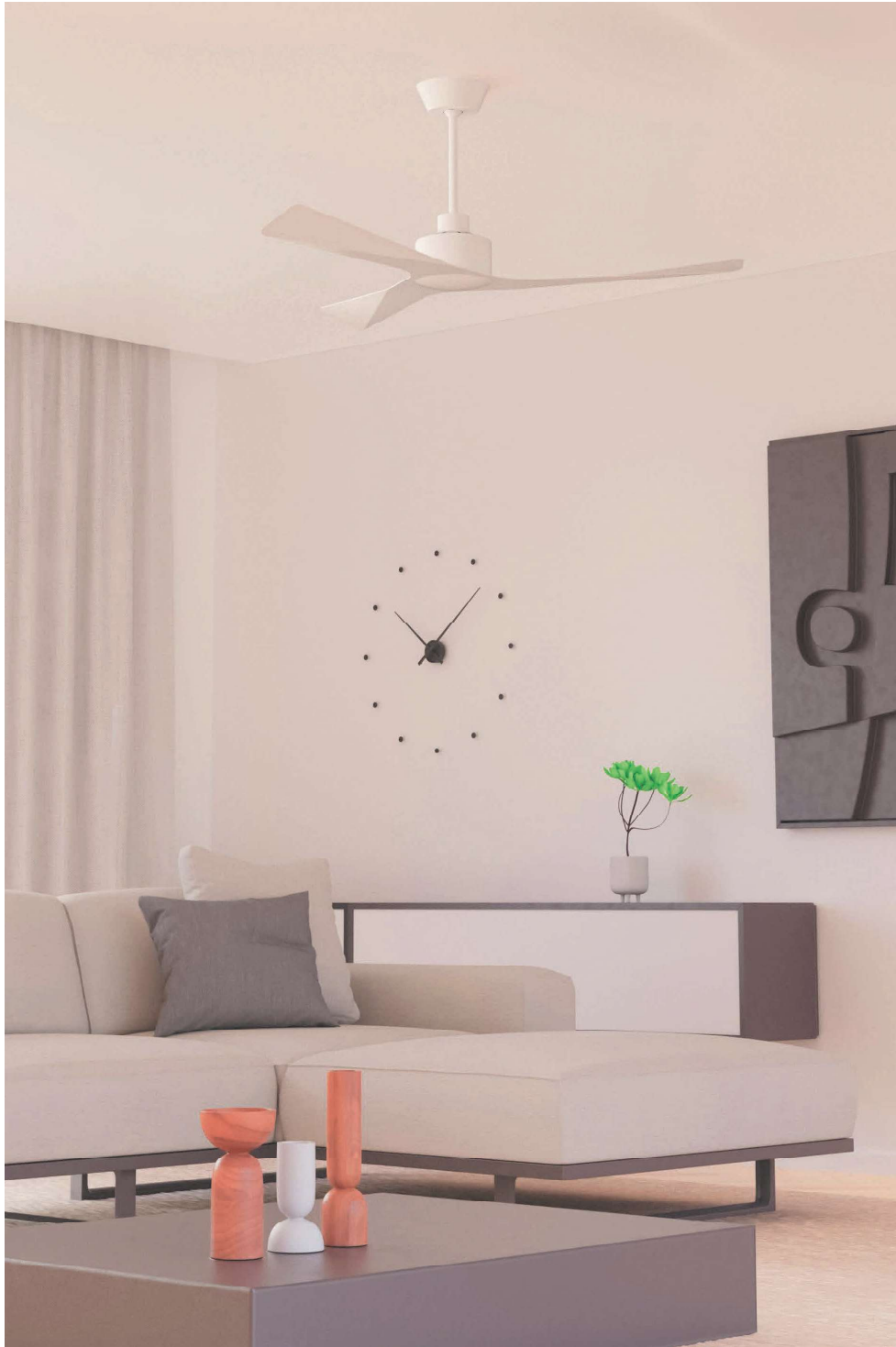

Rodas

STRUCT MAT
Aluminium

BLA MAT
Ply

CLASS I
230V / 50Hz



Fan with accessory bar 71-1964-CF-CF installed

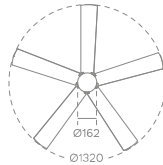
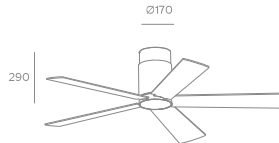

Speed	1	2	3
RPM	90	135	180
W	16	26	53

Code	Structure color	Blade color	Power
30-1964-CF-CF	○ White	○ White	53w

Included	Description	Not included	Code	Description
	Coloured discs for embellished finish		71-4932-00-00	Wall controller for AC motor with light
			71-1964-CF-CF	350mm bar



Kudari

STRUCT MAT
Steel

DIFF MAT
Polycarbonate

BLA MAT
Plywood

CLASS I
100-240V / 50-60Hz

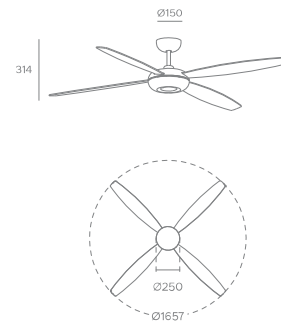

Speed	1	2	3	4	5
RPM	77	100	126	142	180
W	9,5	13,5	20,6	28	52

Code	Structure color	Blade color	Power
30-8546-14-14 S	○ White	○ White / ● Light wood	52W
30-8547-14-14 S	○ White	○ White / ● Light wood	52W



30-8547-14-14

Klar

STRUCT MAT
Steel

DIFF MAT
Glass

BLA MAT
DM

CLASS I
220-240V / 50-60Hz

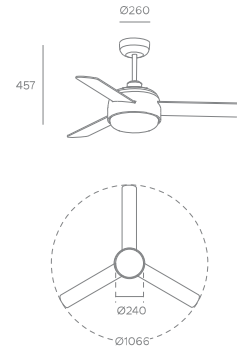

Speed	1	2	3
RPM	100	145	195
W	11	23	42



Code	Structure color	Blade color	Power
30-4864-16-F9 S	○ White	● Light wood / ○ White	72W / Motor power 42W + 2x Max. 15W (LED)*
30-4864-J7-F9 S	● Brown	● Brown / ● Light wood	72W / Motor power 42W + 2x Max. 15W (LED)*

* L=140mm / Ø45mm



Zonda

STRUCT MAT
Steel

DIFF MAT
Polycarbonate

BLA MAT
Polycarbonate

CLASS I
220-240V / 50-60Hz

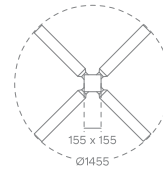
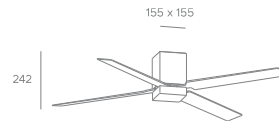
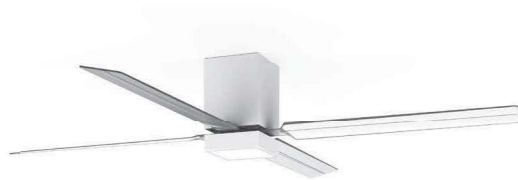

Speed	1	2	3	4	5
RPM	98	118	135	145	178
W	7,5	10	14	19	31

Code	Structure color	Blade color	Power	Kelvin	Rated flux
30-8548-14-M1 S	○ White	○ Transparent	51W / Motor power 31W + 20W (LED)	3000K	2076 lm



30-8549-14-M1

Accessories

Wall control for AC motor



Code	Description	Units
71-4932-00-00	Wall controller for AC motor with light	50



Code	Description	Units
71-4933-00-00	Wall controller for AC motor without light	50

Wall control for DC motor



Code	Description	Units
71-8504-00-00	Wall controller for DC motor with light	60



Code	Description	Units
71-8505-00-00	Wall controller for DC motor without light	60

Bars



Code	Description	Units
71-1844-81-81* S	Satin nickel 460mm bar	10
71-B940-14-14	White 500mm bar	20
71-B940-05-05	Black 500mm bar	20

























Remote control













Code	Description	Units
71-6054-00-00	Remote control for AC motors	50

* Compatible with all models, except for those with DC engine.

Symbols

	Producto nuevo. <i>New product.</i> Nouveau produit.		Fuente de luz LED. <i>LED light source.</i> Source de lumière LED.
	Consultar disponibilidad. <i>Check availability.</i> Vérifiez la disponibilité.		Portalámpara QR-111. <i>QR-111 lamp socket.</i> Porte-lampe QR-111.
	Material reciclado. <i>Recycled material.</i> Matériau recyclé.		Portalámpara GU10. <i>GU10 lamp socket.</i> Porte-lampe GU10.
	Plástico reciclable. <i>Recyclable plastic.</i> Plastique recyclable.		Portalámpara E27. <i>E27 lamp socket.</i> Porte-lampe E27.
	FSC. <i>FSC.</i> FSC.		Portalámpara E14. <i>E14 lamp socket.</i> Porte-lampe E14.
	Luminaria alimentada con energía solar. <i>Solar-powered luminaire.</i> Luminaire alimenté par énergie solaire.		Horas de vida útil. <i>Lifetime in hours.</i> Durée de vie utile.
	Sensor crepuscular. <i>Twilight sensor.</i> Capteur crépusculaire.		Led reemplazable por un profesional. <i>Professional replaceable LED.</i> Led remplaçables par un professionnel.
	Sensor de movimiento. <i>Motion sensor.</i> Capteur de mouvement.		Driver reemplazable por un profesional. <i>Driver replaceable by a professional.</i> Pilote remplaçable par un professionnel.
	Regulador de intensidad. <i>Dimmer.</i> Régulateur d'intensité.		Equipo electrónico incluido. <i>Electronic gear included.</i> Équipement électronique inclus.
	Selección de temperatura de color. <i>Selection of color temperature.</i> Choix de la température de la couleur.		Equipo necesario (no incluido). <i>Gear needed (not included).</i> Équipement nécessaire (non inclus).
	Selección de potencia. <i>Power selection.</i> Sélection de puissance.		Índice de Reproducción Cromática. <i>Color Rendering Index.</i> Indice de rendu des couleurs.
	Regulación progresiva de temperatura de color. <i>Stepless color temperature control.</i> Contrôle progressif de la température de la couleur.		Índice de Deslumbramiento Unificado. <i>Unified Glare Rating.</i> Taux d'éblouissement unifié.
	Luminarias conectables. <i>Smart light fittings.</i> Luminaires connectables.		Ángulo de las ópticas. <i>Lents angle.</i> Angle des lentilles.
	Encendido táctil. <i>Touch.</i> Allumage tactique.		Orientable en eje horizontal. <i>Orientable on the horizontal axis.</i> Orientable sur axe horizontal.
	Luminaria con batería. <i>Battery operated luminaire.</i> Lampe avec batterie.		Orientable en eje vertical. <i>Orientable on the vertical axis.</i> Orientable sur axe vertical.
	Puerto USB. <i>USB port.</i> Le port USB.		Basculante en dos sentidos. <i>Two-way tilting.</i> Inclinaison bidirectionnelle.

	<p>Basculante en un sentido. <i>One way tilting.</i> Basculement dans une direction.</p>		<p>Flujo de aire concentrado <i>Concentrated air flow.</i> Flux d'air concentré.</p>
	<p>Adecuada para instalar en ambientes con atmósfera marina. <i>Suitable for installation in environments with marine atmosphere.</i> Adapté pour une installation en milieu marin.</p>		<p>Flujo de aire. <i>Air flow.</i> Flux d'air.</p>
	<p>Grado de protección proporcionado por un envoltivo contra la entrada de elementos sólidos y líquidos. <i>Degree of protection that a casing provides against the penetration of solid objects or dust and liquids.</i> Degré de protection contre la pénétration de corps solides, poussières et liquides.</p>		<p>Motor DC. <i>DC motor.</i> Moteur DC.</p>
	<p>Grado de protección proporcionado por un envoltivo contra los impactos mecánicos nocivos. <i>Level of protection that a casing provides against damaging mechanical impacts.</i> Degré de protection procuré par une enveloppe contre les impacts mécaniques nuisibles.</p>		<p>Motor AC. <i>AC motor.</i> Moteur AC.</p>
	<p>Producto transitable en zona peatonal. <i>Product can be walked on in pedestrian zone.</i> Produit praticable dans la zone piétonnière.</p>		<p>Ultra silencioso. <i>Ultra-quiet.</i> Ultra-silencieux.</p>
	<p>Función inversa invierno - verano. <i>Inverse function winter - summer.</i> Fonction inverse hiver - été.</p>		<p>Función Brisa. <i>Breeze function.</i> Fonction brise.</p>
	<p>Mando a distancia. <i>Remote control.</i> Télécommande.</p>		<p>Temporizador. <i>Timer.</i> Temporisateur.</p>
	<p>Metros de cable incluido. <i>Meters of cable included.</i> Mètres de câbles inclus.</p>		<p>Sin iluminación. <i>No lighting.</i> Pas d'éclairage.</p>
	<p>Estaca incluida. <i>Spike included.</i> Piquet inclus.</p>		
	<p>Estancia pequeña. <i>Small room.</i> Petite surface.</p>		
	<p>Estancia mediana. <i>Medium room.</i> Moyenne surface.</p>		
	<p>Estancia grande. <i>Large room.</i> Grande surface.</p>		
	<p>Estancia extra grande. <i>Extra large room.</i> Très grande surface.</p>		
	<p>Flujo de aire amplio. <i>Ample airflow.</i> Flux d'air ample.</p>		

Numeric index

Reference	Page	Reference	Page	Reference	Page	Reference	Page
30-1964-CF-CF	346	DE-0116-ORO	143	DE-0199-BLA	132	DE-0288-BLA	96
30-4356-CF-CF	344	DE-0117-BLA	145	DE-0200-NAT	114		130
30-4393-CF-M1	336	DE-0117-NEG	145	DE-0201-NAT	124	DE-0288-NEG	96
30-4393-N3-M1	336	DE-0117-ORO	145	DE-0213-NAT	90		130
30-4398-16-16	334	DE-0118-BLA	148	DE-0214-NAT	90	DE-0289-BLA	96
30-4398-J7-J7	334	DE-0118-NEG	148	DE-0215-NAT	112	DE-0289-NEG	96
30-4864-16-F9	348	DE-0121-NEG	78	DE-0217-ESP	82	DE-0290-BLA	102
30-4864-J7-F9	348	DE-0122-NEG	78	DE-0218-ESP	82	DE-0290-NEG	102
30-5378-14-F9	324	DE-0123-BLA	110	DE-0219-NAT	138	DE-0291-BLA	134
30-7644-CF-F9	332	DE-0124-NEG	75	DE-0220-NAT	138	DE-0291-NEG	134
30-7972-14-F9	320	DE-0125-NEG	75	DE-0221-NAT	138	DE-0292-BLA	134
30-7973-14-F9	320	DE-0127-NEG	74	DE-0222-NAT	138	DE-0292-NEG	134
30-8546-14-14	347	DE-0128-CRO	41	DE-0229-BLA	108	DE-0293-BLA	134
30-8547-14-14	347		70	DE-0231-BLA	109	DE-0293-NEG	134
30-8548-14-M1	348	DE-0129-BLA	40	DE-0232-BLA	109	DE-0428-CRO	79
30-8644-81-92	310		71	DE-0233-BLA	100	DE-0429-CRO	79
30-8644-81-93	310	DE-0129-CRO	40	DE-0236-NAT	92	DE-0442-SAT	146
30-8645-81-92	310		71	DE-0237-NEG	72	DE-0477-BLA	122
30-8645-81-93	310	DE-0129-NEG	40	DE-0238-NEG	72	DE-0509-BLA	108
71-1844-81-81	349		71	DE-0240-NEG	72	DE-0509-NEG	108
71-1964-CF-CF	346	DE-0130-BLA	39	DE-0241-NEG	76	PX-0005-ANT	253
71-4393-N3-N3	336		68	DE-0242-NEG	76	PX-0005-GRI	253
71-4932-00-00	349	DE-0130-NEG	39	DE-0247-AZU	106	PX-0028-OXI	252
71-4933-00-00	349		68	DE-0247-BEI	106	PX-0029-MAR	277
71-6054-00-00	349	DE-0131-BLA	66	DE-0247-NAR	106	PX-0033-ANT	277
71-8504-00-00	349	DE-0131-NEG	66	DE-0247-VER	106	PX-0047-GRI	180
71-8505-00-00	349	DE-0132-BLA	38	DE-0248-BEI	98	PX-0056-GRI	250
71-B940-05-05	349		71	DE-0249-BEI	126	PX-0056-NEG	250
71-B940-14-14	349	DE-0133-NEG	74	DE-0249-ROJ	126	PX-0086-ANT	275
DE-0000-BLA	111	DE-0134-NEG	120	DE-0249-VER	126	PX-0087-ANT	275
DE-0001-BLA	111	DE-0135-NEG	128	DE-0250-BEI	116	PX-0099-ANT	276
DE-0003-SAT	147	DE-0136-NEG	104	DE-0268-BLA	144	PX-0099-INO	276
DE-0004-SAT	111	DE-0171-NEG	140	DE-0268-NEG	144	PX-0100-ANT	276
DE-0020-BLA	118	DE-0172-NEG	140	DE-0271-BLA	121	PX-0100-INO	276
DE-0020-GRI	118	DE-0173-NEG	140	DE-0271-NEG	121	PX-0102-ANT	276
DE-0023-NEG	94	DE-0174-NEG	140	DE-0272-BLA	129	PX-0103-ANT	276
DE-0024-NEG	94	DE-0175-NEG	123	DE-0287-BLA	96	PX-0122-INO	181
DE-0115-BLA	149	DE-0176-ESP	80		130	PX-0123-INO	166
DE-0115-NEG	149	DE-0177-ESP	80	DE-0287-NEG	96	PX-0127-NEG	250
DE-0116-BLA	143	DE-0178-ESP	80		130	PX-0128-INO	166
DE-0116-NEG	143	DE-0179-NAT	95			PX-0134-NEG	274

Reference	Page	Reference	Page	Reference	Page	Reference	Page
PX-0135-NEG	194	PX-0358-NEG	62	PX-0433-ANT	214	PX-0564-NEG	288
PX-0139-NEG	266		179	PX-0433-BLA	214	PX-0565-NEG	288
PX-0140-NEG	251	PX-0360-NEG	195	PX-0451-NEG	162	PX-0566-NEG	290
PX-0141-NEG	251	PX-0361-NEG	193		192	PX-0593-NEG	159
PX-0144-NEG	193	PX-0366-NEG	203	PX-0454-ANT	220		219
PX-0148-ANT	254	PX-0370-ALU	60	PX-0465-INO	180	PX-0623-NEG	245
PX-0171-ANT	163		170	PX-0468-ANT	212	PX-0624-NEG	245
	220	PX-0370-BLA	60	PX-0468-BLA	212	PX-0625-BLA	248
PX-0172-ANT	163		170	PX-0486-NEG	213	PX-0625-GRI	248
	267	PX-0370-NEG	60	PX-0487-NEG	265	PX-0625-NEG	248
PX-0173-ANT	163		170	PX-0499-NEG	242	PX-0627-ANT	257
	267	PX-0371-ALU	60	PX-0500-NEG	273	PX-0628-ANT	268
PX-0197-NEG	206		170	PX-0501-NEG	273	PX-0629-ANT	268
PX-0214-NEG	198	PX-0371-BLA	60	PX-0507-BLA	207	PX-0630-ANT	268
PX-0246-INO	254		170	PX-0507-NEG	207	PX-0633-NEG	195
PX-0252-NEG	244	PX-0371-NEG	60	PX-0510-BLA	283	PX-0634-NEG	196
PX-0263-NEG	162		170	PX-0512-BLA	283	PX-0636-NEG	196
	296	PX-0374-NEG	192	PX-0513-BLA	283	PX-0637-NEG	226
PX-0287-GRI	221	PX-0375-ANT	238	PX-0518-BLA	283	PX-0638-NEG	226
PX-0287-NEG	221	PX-0375-BLA	238	PX-0520-INO	167	PX-0644-NEG	255
PX-0306-GRI	52	PX-0375-MAR	238	PX-0523-NEG	202	PX-0645-NEG	255
PX-0307-GRI	52	PX-0376-ANT	238	PX-0524-NEG	272	PX-0646-NEG	160
PX-0308-GRI	52	PX-0376-BLA	238	PX-0525-ANT	212	PX-0647-MAR	186
PX-0345-BLA	240	PX-0376-MAR	238	PX-0525-BLA	212	PX-0647-NEG	186
PX-0345-NEG	240	PX-0378-BLA	234	PX-0526-ANT	216	PX-0648-MAR	186
PX-0349-GRI	174	PX-0378-GRI	234	PX-0526-BLA	216	PX-0648-NEG	186
PX-0350-BLA	62	PX-0378-NEG	234	PX-0533-NEG	198	PX-0649-NEG	221
	232	PX-0379-BLA	234	PX-0534-ANT	233	PX-0650-NEG	221
PX-0350-NEG	62	PX-0379-GRI	234	PX-0535-ANT	233	PX-0651-ANT	238
	232	PX-0379-NEG	234	PX-0536-ANT	233	PX-0651-BLA	238
PX-0351-BLA	62	PX-0380-BLA	278	PX-0537-ANT	264	PX-0651-MAR	238
	232	PX-0380-GRI	278	PX-0540-ALU	178	PX-0664-NEG	256
PX-0351-NEG	62	PX-0380-NEG	278	PX-0541-ALU	178	PX-0665-NEG	270
	232	PX-0383-ANT	243	PX-0545-NEG	247	PX-0666-NEG	270
PX-0352-BLA	249	PX-0395-NEG	232	PX-0546-NEG	246	PX-0667-NEG	270
PX-0352-GRI	249	PX-0396-NEG	232	PX-0549-ALU	178	PX-0668-NEG	222
PX-0352-NEG	249	PX-0397-NEG	212	PX-0550-NEG	246	PX-0669-NEG	262
PX-0355-INO	166	PX-0423-GRI	174	PX-0551-NEG	247	PX-0670-NEG	190
PX-0357-NEG	62	PX-0432-ANT	216	PX-0556-NEG	202	PX-0671-MAR	188
	179	PX-0432-BLA	216	PX-0557-ANT	168	PX-0671-NEG	188
		PX-0432-MAR	216	PX-0563-NEG	214	PX-0672-MAR	188

Numeric index

Reference	Page	Reference	Page	Reference	Page	Reference	Page
PX-0672-NEG	188	PX-0760-BLA	278	TC-0070-BLA	42	TC-0161-BLA	46
PX-0690-BLA	286	PX-0760-NEG	278	TC-0070-NEG	42	TC-0162-BLA	46
PX-0690-NEG	286	PX-0761-NEG	164	TC-0071-BLA	42	TC-0163-BLA	46
PX-0691-MAR	208	PX-0765-NEG	280	TC-0071-NEG	42	TC-0166-BLA	47
PX-0691-NEG	208	PX-0766-NEG	184	TC-0072-BLA	32	TC-0167-BLA	47
PX-0691-VRD	208	PX-0767-NEG	200	TC-0073-BLA	32	TC-0168-BLA	47
PX-0692-MAR	258	PX-0768-NEG	182	TC-0074-BLA	32	TC-0169-BLA	47
PX-0692-NEG	258	PX-0769-GRI	52	TC-0075-BLA	53	TC-0175-BLA	30
PX-0692-VRD	258	PX-0770-BLA	224	TC-0078-BLA	136	TC-0176-BLA	30
PX-0693-NEG	158	PX-0770-NEG	224	TC-0078-NEG	136	TC-0182-BLA	56
	218	PX-0771-ALU	172	TC-0079-BLA	101	TC-0182-NEG	56
PX-0695-MAR	210	PX-0772-ALU	172	TC-0079-NEG	101	TC-0200-BLA	43
PX-0695-NEG	210	PX-0773-ALU	172	TC-0080-BLA	142	TC-0203-BLA	24
PX-0695-VRD	210	PX-0774-BLA	240	TC-0080-NEG	142	TC-0204-BLA	24
PX-0696-MAR	260	PX-0774-NEG	240	TC-0081-BLA	26	TC-0212-BLA	25
PX-0696-NEG	260	PX-1000-INO	166	TC-0082-BLA	26	TC-0213-BLA	25
PX-0696-VRD	260	PX-1200-NEG	164	TC-0083-BLA	26	TC-0215-BLA	30
PX-0697-NEG	294	PX-1400-BLA	199	TC-0084-BLA	26	TC-0216-BLA	30
PX-0698-VRD	292	PX-1400-GRI	199	TC-0085-BLA	26	TC-0220-BLA	43
PX-0699-BLA	204	PX-1400-NEG	199	TC-0105-BLA	130	TC-0220-NEG	43
PX-0700-BLA	204	PX-1801-BLA	282	TC-0106-BLA	130	TC-0235-BLA	50
PX-0701-BLA	204	PX-1801-GRI	282	TC-0111-BLA	42	TC-0235-NEG	50
PX-0702-BLA	204	TC-0000-BLA	22	TC-0112-BLA	36	TC-0237-BLA	50
PX-0751-NEG	63	TC-0000-NEG	22	TC-0112-NEG	36	TC-0237-NEG	50
	228	TC-0001-BLA	22	TC-0113-BLA	36	TC-0240-SIN	50
PX-0752-NEG	230	TC-0001-NEG	22	TC-0113-NEG	36	TC-0248-BLA	48
PX-0753-NEG	230	TC-0002-BLA	22	TC-0118-BLA	35	TC-0248-NEG	48
PX-0754-NEG	230	TC-0002-NEG	22	TC-0119-BLA	35	TC-0249-BLA	48
PX-0755-NEG	63	TC-0003-BLA	22	TC-0120-BLA	35	TC-0249-NEG	48
	228	TC-0003-NEG	22	TC-0121-BLA	35	TC-0250-BLA	54
PX-0756-BLA	58	TC-0004-BLA	22	TC-0134-BLA	37	TC-0250-NEG	54
	176	TC-0004-NEG	22	TC-0135-BLA	37	TC-0251-BLA	44
PX-0756-GRI	58	TC-0005-BLA	22	TC-0148-BLA	24	TC-0251-NEG	44
	176	TC-0005-NEG	22	TC-0149-BLA	24	TC-0252-BLA	44
PX-0756-NEG	58	TC-0006-BLA	22	TC-0150-BLA	24	TC-0252-NEG	44
	176	TC-0006-NEG	22	TC-0151-BLA	24	TC-0303-BLA	43
PX-0757-ANT	275	TC-0007-BLA	22	TC-0154-BLA	25	TC-0304-BLA	43
PX-0758-BLA	236	TC-0007-NEG	22	TC-0155-BLA	25	TC-0349-BLA	33
PX-0758-NEG	236	TC-0046-BLA	54	TC-0156-BLA	25	TC-0350-BLA	33
PX-0759-BLA	236	TC-0047-BLA	54	TC-0157-BLA	25	TC-0366-BLA	43
PX-0759-NEG	236	TC-0047-NEG	54	TC-0160-BLA	46	TC-0366-NEG	43

Reference	Page	Reference	Page
TC-0411-BLA	46	VE-0095-BFF	302
TC-0412-BLA	46	VE-0095-BNE	302
TC-0413-BLA	47	VE-0095-NBL	302
TC-0414-BLA	47	VE-0095-NFC	302
TC-0415-BLA	46	VE-0095-NFF	302
TC-0416-BLA	46	VE-0095-NNE	302
TC-0440-BLA	28	VE-0096-BBL	304
TC-0472-BLA	28	VE-0096-BFC	304
TC-0476-BLA	42	VE-0096-BFF	304
TC-0491-BLA	28	VE-0096-BNE	304
TC-0502-BLA	33	VE-0096-NBL	304
TC-1200-BLA	41	VE-0096-NFC	304
	70	VE-0096-NFF	304
TC-1400-BLA	34	VE-0096-NNE	304
TC-1401-BLA	34	VE-0097-BBL	306
TC-1500-BLA	34	VE-0097-BFC	306
TC-1900-BLA	42	VE-0097-BFF	306
TC-1900-NEG	42	VE-0097-BNE	306
TC-1901-BLA	42	VE-0097-NBL	306
TC-1901-NEG	42	VE-0097-NFC	306
VE-0004-BLA	330	VE-0097-NFF	306
VE-0005-BLA	330	VE-0097-NNE	306
VE-0006-BLA	342	VE-0098-BBL	308
VE-0006-MAR	342	VE-0098-BFC	308
VE-0006-PAT	342	VE-0098-BFF	308
VE-0006-SAT	342	VE-0098-BNE	308
VE-0007-BLA	322	VE-0098-NBL	308
VE-0016-BLA	326	VE-0098-NFC	308
VE-0020-NEG	328	VE-0098-NFF	308
VE-0022-BLA	326	VE-0098-NNE	308
VE-0023-BLA	326		
VE-0028-NEG	341		
VE-0033-MAD	339		
VE-0034-NEG	340		
VE-0035-MAD	338		
VE-0091-BLA	314		
VE-0092-NEG	312		
VE-0093-MAR	318		
VE-0094-BLA	316		
VE-0095-BBL	302		
VE-0095-BFC	302		

Alphabetical index

Name	Page	Name	Page	Name	Page	Name	Page
Accessory Fans	349	Ding	121	Icon	62	Mim	339
Alan	245		129		179	Mine	145
Alfil	277	Dorit	33	Ilo	50	Minimal	193
Ander	110	Duplo	102	Incasso	167	Minor	41
Ara	238	Easy	24	Indoo	274		70
Area	248		25	Janet	149	Mix	42
	249		46	Jet	22		43
Arrow	266		47		44	Mode	32
Astra	257	Eclipta I	208	Jim	34	Mogan	344
	268		258	July	328	Moo	204
Aura	148	Eclipta II	210	Jumbo	194	Nature	138
Auro	224		260	Kairo	63	Neo	192
Avenue	244	Element	26		228	Nepal	332
Bala	28	Eleve	203		230	New Flash	207
Bambu	338	Era	48	Kala	243	Niza	111
Bas	146		101		276	Nod	62
Base	33		136	Kapa	212		232
Baser	292		142	Kaplan	134	Nora	78
Block	220	Eufo	140	Keop	108	Nube	100
Bora	314	Fab	66	Klar	348	Nuts	118
	320	Farrow	132	Koral	276	Olaf	158
Borneo	342	Feu	40	Kubo	251		218
Bosc	312	Fint	71	Kudari	347	One	222
Calar	326	Fois	188	Lab	38		262
Cardan	35	Fond	240		71	Orion	234
Cero	160	Ford	282	Lace	322		236
Cil	340	Formentera	336	Lis	162		278
Colo	143	Fres	98		192	Osaka	252
Cone	242		106	Lizz	80	Ousia	196
	273		116	Loyd	232	Passaggio	76
Cortic	90		126	Lungo	79	Phuket	334
	112	Garbí	324	Luvo	56	Pious	190
Crest	184	Giro	74	Lyon	147	Pixa	198
	280	Glass	111	Mandela	275		202
Creu	226	Helix	316	Mayor	253		272
Crobat	144	Hide	30	Meds	104	Pomer	286
Cube	250		233		120	Pop	52
Dama	92		264		128	Post	199
Deco	162	Hit	195	Merak	341	Prisma	247
	296			Metà	75	Quanta	255

Name	Page	Name	Page
Rame	41	Top	163
	70		220
Rect	178		267
Ret Solar	159	Toppi	109
	219	Touch	122
Rex	216	Treta	288
Riba	94	Trim	186
Ringo	166	Up	168
Rodas	346	Veta	256
Rorer	294		270
Samper	221	Vista	182
Scal	283		200
Senya	60	Vit	206
	170	Viva	95
	172		114
Sfera	72		124
Shadow	318	Wall controller	349
Sicro	36	Way	174
Silian	277	Wilow	212
Siluet	254	Windy	330
Sirina	290	Yika	213
Slim	214		265
Sound Plus	37	Zenit	123
Square eco	53	Zenitha	221
Stac	96	Zico	82
	130	Zilo	58
Stair	181		176
Stem	310	Zonda	348
Stem Evo	302		
	304		
	306		
	308		
Tamesis	180		
Tent	54		
Ter	39		
	68		
Thin	108		
Thomas	254		
Tidian	164		
	198		

Certificado de garantía
Warranty Certificate
Certificat de garantie

LedsC4, S.A. garantiza al consumidor y usuario el correcto funcionamiento del producto y posibles reparaciones o suministro de recambios del modelo debidos a defectos de fabricación durante el periodo de 3 o 5 años desde la fecha de entrega. En www.forlight.com se pueden consultar las condiciones de garantía, de las cuales destacamos las siguientes excepciones:

- En fuentes de luz LED, cuyo funcionamiento supera a las horas de máximo uso por año declaradas en las condiciones de garantía específica del producto.
- Accidentes, o uso negligente, impropio o inadecuado.
- Daños producidos por sobrecargas eléctricas, inundaciones, plagas, terremotos, acciones de terceras partes o cualesquiera otras causas de fuerza mayor ajenas a las condiciones normales de funcionamiento del equipo y al control de LedsC4, S.A.

This warranty certificate by LedsC4, S.A. is for the consumer and user to guarantee the product works properly, and it covers the model's possible repairs and supply of spare parts due to manufacturing defects for a period of 3 or 5 years from the delivery date. The warranty terms and conditions can be consulted at the following link www.forlight.com. Please take note of the following exceptions:

- *In LED light sources, whose operation exceeds the maximum hours of use per year declared in the specific warranty conditions of the product.*
- *Accidents or negligent, improper and inappropriate use.*
- *Damage caused by electrical overloads, floods, infestations, earthquakes, actions of third parties or any other cause of force majeure beyond the normal operating conditions of the equipment and the control of LedsC4, S.A.*

LedsC4, S.A. garantit au consommateur et utilisateur le fonctionnement correct du produit, ainsi que les éventuelles réparations ou la fourniture de pièces de rechange du modèle dues à des défauts de fabrication pendant une période de 3 ou 5 ans à compter de la date de livraison. Vous pouvez consulter les conditions de garantie sur www.forlight.com, dont il convient de signaler les exceptions suivantes:

- En sources lumineuses LED, dont le fonctionnement dépasse le nombre maximal d'heures d'utilisation par an déclaré dans les conditions de garantie spécifiques au produit.
- Accidents ou utilisation négligente, impropre ou inadéquate.
- Dommages occasionnés par des surcharges électriques, inondations, fléaux, tremblements de terre, actions de tiers ou toutes autres causes de force majeure indépendantes des conditions normales de fonctionnement du matériel et du contrôle de LedsC4, S.A.

Información de tarifa
Price list information
Information tarifaire

Todos los precios indicados en el catálogo incluyen la tasa ECORAE.

All prices featured in the catalogue include the WEEE eco-fee.

Tous les prix indiqués dans le catalogue comprennent l'éco-participation DEEE.

Información extra
Extra information
Informations supplémentaires

Todos los derechos reservados. Ninguna parte de este libro puede ser reproducida en ningún formato de papel o electrónico, sin el consentimiento previo del editor o de los propietarios de los derechos. Ningún producto del catálogo incluye la bombilla, aunque ésta aparezca en las fotografías. Debido a la constante evolución tecnológica del LED, los productos que incluyen esta fuente de luz pueden experimentar variaciones en sus características técnicas con el objetivo de poder ofrecer siempre las máximas prestaciones en nuestros productos.

All rights reserved. No part of this publication may be reproduced or transmitted in any form or by any means, electronic storage and retrieval system, without permission in writing from the copyright owner(s). The products in this catalogue do not include bulbs, although bulbs may appear in the photos. Due to the constant evolution of LED technology, products containing this light source may vary in their technical characteristics so as to ensure that we can always offer maximum product performance.

Tous droits réservés. Aucune partie de ce catalogue ne pourra être reproduite en format papier ou électronique sans l'autorisation préalable de l'éditeur ou du propriétaire des droits. Les ampoules ne sont pas incluses aux produits de ce catalogue même dans le cas où les photos pourraient laisser penser le contraire. En raison de l'évolution constante de la technologie LED, les produits dotés de cette source lumineuse peuvent connaître des variations dans leurs caractéristiques techniques, en vue de toujours en optimiser les prestations.

Headquarters



LedsC4

Afores s/n
25750 Torà
Lleida — Spain
+ 973 468 100
ledsc4@ledsc4.com

CUSTOMER SERVICE

SPAIN
+ 34 973 468 101
spain@ledsc4.com

GERMANY
+49 209 882 99 021
deutschland@ledsc4.com

EUROPE
+ 34 973 468 102
europe@ledsc4.com

LATIN AMERICA
+ 34 973 468 115
latinamerica@ledsc4.com

UNITED KINGDOM
Free-phone: 0808 234 2641
uk@ledsc4.com

ITALY
Toll-free: 800 784 275
italia@ledsc4.com

ASIA PACIFIC
+ 34 973 468 116
asiapacific@ledsc4.com

CANADA
Toll-free: + 1-866-5636666
customerserviceUS@ledsc4.com

FRANCE
+ 34 973 468 130
france@ledsc4.com

PORTUGAL
+ 34 973 468 102
portugal@ledsc4.com

AFRICA
+ 34 973 468 116
africa@ledsc4.com

UNITED STATES
Toll-free: + 1-888-3710243
customerserviceUS@ledsc4.com

C1218

forlight.com



Técnico interior
Indoor technical
Technique intérieure

Baño
Bathroom
Salle de bains

Decorativo interior
Indoor decorative
Décoratif intérieur

Exterior
Outdoor
Extérieur

Portátil
Portable
Portable

Ventiladores
Fans
Ventilateurs

forlight.com

Alfores, s/n. 25759 Torà
Lleida, Spain | T 34 973 468 100

ESP

ENG

FRA